

## Operator's Manuals

**EXT 311**

[\(click here\)](#)

**EXT 515**

[\(click here\)](#)

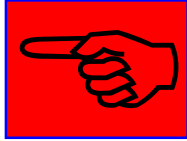

# Clarke®

Division of  
ALTO®

## Operator's Manual

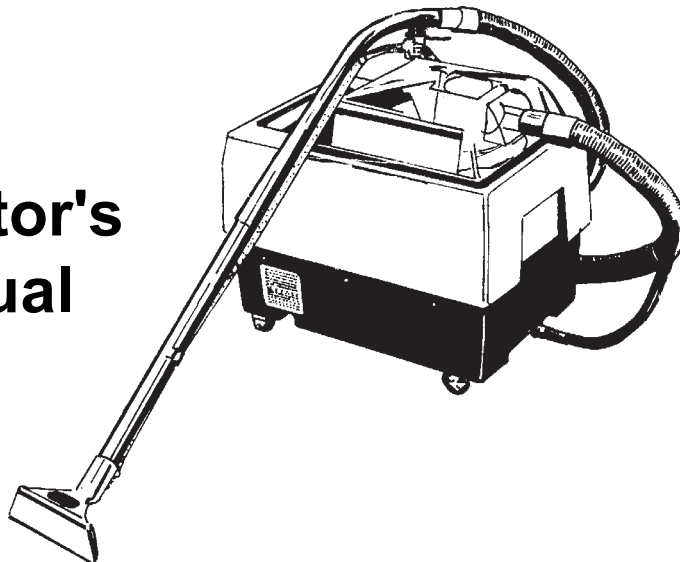

## EXT 311 Extractor

### **READ THIS BOOK**

This book has important information for the use and safe operation of this machine. Failure to read this book prior to operating or attempting any service or maintenance procedure to your Clarke machine could result in injury to you or to other personnel; damage to the machine or to other property could occur as well. You must have training in the operation of this machine before using it. If your operator(s) cannot read English, have this manual explained fully before attempting to operate this machine.

Si Ud. o sus operadores no pueden leer el Inglés, se hagan explicar este manual completamente antes de tratar el manejo o servicio de esta máquina.

All directions given in this book are as seen from the operator's position at the rear of the machine.

For new books write to: Clarke®, 2100 Highway 265, Springdale, Arkansas 72764.

## CONTENTS OF THIS BOOK

Operator Safety Instructions .....	1
Introduction and Machine Specifications .....	2
Controls and Machine Features .....	3
How to Prepare the Machine for Operation .....	4
Instructions for Connection to the Power Supply - 120V Extension Cords - 120V .....	5
Instructions for Connection to the Power Supply - 230V Extension Cords - 230V .....	6
Machine Operating Instructions .....	7
How to Clean an Area of Carpet .....	7
How To clean a Larger Area of Carpet .....	7
Maintenance .....	8
After Each Use of the Machine .....	8
How to Prevent Damage from Freezing Temperatures .....	9
The Pump and Vacuum Motor .....	9
How To Check The Commutator and The Carbon Brushes .....	10
How to Correct Problems in the Machine .....	11
Machine Variables and Accessories .....	12
Ext-311 Assembly Drawing .....	14
Parts List .....	15
Ext -311 Base Assembly Drawing .....	16
Parts List .....	17
Ext-311 Solution Tank Assembly Drawing & Parts List .....	18
Ext-311 Hose Assembly Drawing & Parts List .....	19
Ext-311 Pump Drawing & Parts List .....	20
Motor Drawing & Parts List 120V .....	21
Motor Drawing & Parts List 230V .....	22
Electrical Schematic 120V .....	23
Wiring Diagram .....	24
Electrical Schematic 230V .....	25
Wiring Diagram .....	26

## OPERATOR SAFETY INSTRUCTIONS



**WARNING**





**AVERTISSEMENT**



**ADVERTENCIA**

For the safe operation of this machine, read and understand all warnings and cautions.

-  **DANGER** means: Severe bodily injury or death can occur to you or other personnel if the **DANGER** statements found on your machine or in your Owner's Manual are ignored or are not adhered to. Read and observe all **DANGER** statements found in your Owner's Manual and on your machine.
-  **WARNING** means: Injury can occur to you or to other personnel if the **WARNING** statements found on your machine or in your Owner's Manual are ignored or are not adhered to. Read and observe all **WARNING** statements found in your Owner's Manual and on your machine.
-  **CAUTION** means: Damage can occur to the machine or to other property if the **CAUTION** statements found on your machine or in your Owner's Manual are ignored or not adhered to. Read and observe all **CAUTION** statements found in your Owner's Manual and on your machine.



**DANGER:** Machines can cause an explosion when operated near flammable materials and vapors. Do not use this machine with or near fuels, grain dust, solvents, thinners, or other flammable materials.



**DANGER:** Do not immerse. To reduce the risk of an electric shock, use only on a carpet that has been moistened by a cleaning process. Protect the machine from rain. Keep the machine in a dry building. Always clean the machine with a clean dry cloth.



**WARNING:** You must have training in the operation of this machine before using it. **READ THE INSTRUCTION BOOK FIRST.**



**WARNING:** Always use a three-wire electrical system connected to the electrical ground. For maximum protection against electric shock, use a circuit that is protected by a ground fault circuit interrupter. Consult your electrical contractor.



**WARNING:** To prevent electric shock, always remove the electrical plug from the electrical outlet before doing any repairs or maintenance to this machine.



**WARNING:** Do not use this machine as a step or furniture. Injury could occur to the operator.



**WARNING:** To avoid serious injury, use proper lifting procedures when lifting the machine.



**WARNING:** Maintenance and repairs must be done by authorized personnel only.



**WARNING:** Keep all fasteners tight. Keep the adjustments according to specifications.



**WARNING:** Make sure that all the labels, decals, warnings, cautions and instructions are fastened to the machine. Replace them when necessary by ordering them from Clarke.





**WARNING:** Do not use water that is hotter than 140°F (60°C).



**WARNING:** If foam/liquid comes out, switch machine off immediately.

## OPERATOR SAFETY INSTRUCTIONS (CONT.)

 **WARNING:** Improper discharge of waste water may damage the environment and be illegal. The United States Environmental Protection Agency has established certain regulations regarding discharge of waste water. Also, city and state regulation regarding this discharge may be in effect in your area. Understand and follow the regulations in your area. Be aware of the environmental hazards of chemicals that you dispose.

 **CAUTION:** To prevent damage to the power cord, do not move this machine over the power cord, instead, lift the power cord over the machine. If the cord supplied is damaged, it must be replaced by the manufacturer, its service agent or a similarly qualified person in order to avoid the hazard.

 **CAUTION:** To prevent damage to the power cord and hoses, do not use the power cord or hoses to pull the machine.

## INTRODUCTION and MACHINE SPECIFICATIONS

- The Model 311 is an extractor for cleaning carpet. When used with a floor tool, the machine applies cleaning solution to the carpet and removes the dirty solution and soil from the carpet.
- The extractor has controls to start the pump for the solution and the motor for the vacuum. The floor tools have controls to release the solution and to operate the brush.
- The extractor has a demand pump. The pump starts when the solution lever on the floor tool is activated. The pump stops when the lever is released.

Model	EXT-311 Plus	EXT-311 CE
Code Number	04090A	04095A
Electrical	120 V 60 Hz	230V 50/Hz.
Current (Amps)	8.5	6
Solution Pump Pressure	100 psi	6.8 bar
Solution Tank Capacity	11 gal	41.6 liters
Recovery Tank Capacity	3 gal	11.4 liters
Solution Flow per minute	2.0 gallons	7.6 liters
Vacuum Motor Power	1 hp	0.74 kW
Power Cable Length	35'	10 m
Wheels, Number-Diameter	4 - 2"	4 - 51 mm
Dimensions (LxWxH)	25"L x 17½"W x 22¼"H	63.5cm x 44.5cm x 56.5cm
Weight	40 lbs.	18 kg
Shipping Weight	45 lbs.	20 kg
Warranty	1 year	1 year
Sound Level (dBA)	-	<70

**NOTE:** When using the extractor to clean carpets, follow this procedure:

1. Do not walk on freshly cleaned carpets for at least four hours or until the carpet is dry to touch.
2. Do not remove aluminum or plastic pieces that have been placed under the legs of furniture until the carpet is dry.
3. Do not allow children or pets to crawl or walk around on the damp carpet.
4. Vacuum right after the carpet is dry and then vacuum the carpet once a week as needed.

## CONTROLS and MACHINE FEATURES

### The Vacuum Motor Switch

The vacuum motor switch is on the back of the machine. Put the switch in the "I" position to start the motor. Put the switch in the "O" position to stop the motor.

### The Switch To Activate The Pump

The switch to start/stop the pump motor is on the back of the machine. Put the switch in the "I" position to start the pump motor. Press the lever on the floor tool to start the solution flow. Release the levers on the floor to stop the solution flow. Put the switch in the "O" position to stop the pump motor.

**NOTE: While the machine is in operation, the pump will shut-off automatically when it reaches full pressure. The pump will automatically turn on when the pressure decreases.**

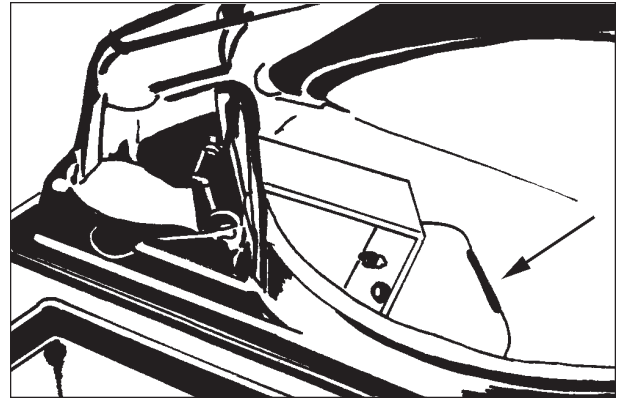

Figure 1

### The Float Shut-Off See figure 1

The float shut-off is in the recovery tank. When the liquid raises the float, the air stops moving through the machine.

### The Vacuum Hose Connector See figure 2

The vacuum hose connector is on the dome assembly.

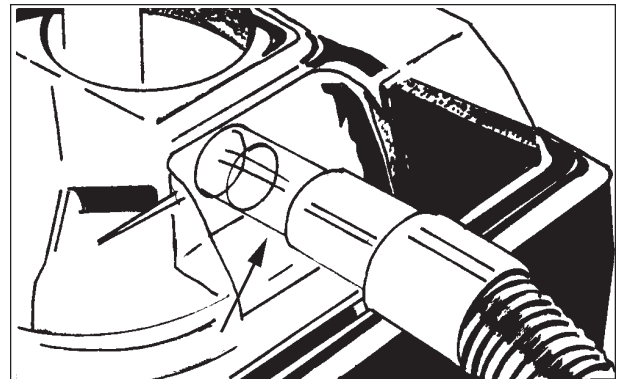

Figure 2

### The Solution Hose Connector See figure 3

The solution hose connector is on the lower part of the extractor, below the vacuum hose connector.

### The Recovery Tank

The recovery tank is in the top of the machine. Make sure the white pail is in the tank when the machine is running.

### The Solution Tank

The solution tank is in the top of the machine next to the recovery tank.

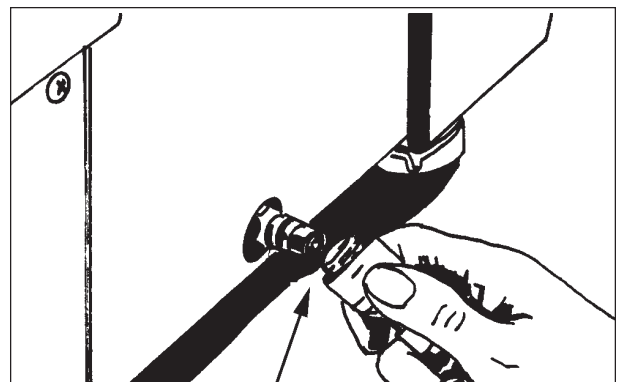

Figure 3

## HOW TO PREPARE THE MACHINE FOR OPERATION

To prepare the machine for operation, follow this procedure:

1. Connect the vacuum hose to the hose connector on the extractor and to the end of the vacuum tube on the floor tool.
2. Connect the solution hose to the extractor and the floor tool. To fasten the quick disconnect fitting, slide the knurled collar on the female coupling away from the opening. Push the male coupling into the female coupling. See figure 4

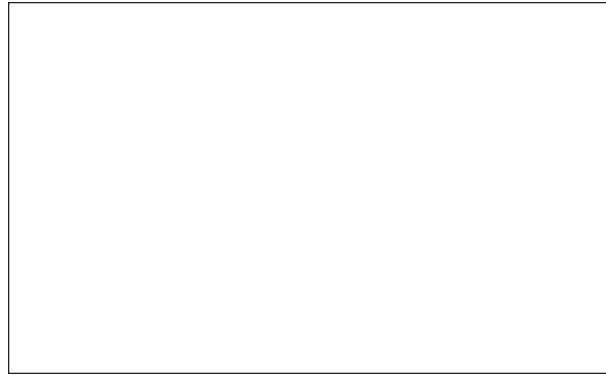

Figure 4

**⚠ WARNING:** Do not use water that is hotter than 140°F (60°C).

3. Before moving the extractor onto the carpet, put clean hot water into the solution tank.
4. Add a cleaning chemical, such as Clarkare® Extractor Concentrate, to the hot water. For the correct amount, follow the directions shown on the container.
5. If the extractor removes an excess amount of foam from the carpet, add a de-foamer such as Clarkare® De-foamer Concentrate to the recovery tank. The amount needed will vary according to the amount of detergent already in the carpet.

**⚠ CAUTION:** To prevent damage, use a water-based de-foamer rather than an oil-based de-foamer.

**⚠ CAUTION:** Do not leave the extractor or other cleaning machines or tools on the carpet when not in use. Cleaning solution in the machines and tools can leak onto the carpet and cause light spots or stains.

**NOTE:** To order Clarkare® Extractor Concentrate, order part no. 398421. To order Clarkare® Defoamer, order part no. 398420.

For instructions for preparation and operation of your floor tool or power brush tool, read the operator's manual given with your floor tool or power brush tool.

**INSTRUCTIONS FOR CONNECTION TO THE  
POWER SUPPLY AND ELECTRICAL GROUND - 120 V**

**⚠ CAUTION:** This machine will operate only on an AC frequency and on the specified electrical voltage shown on the nameplate. Make sure you have the correct frequency and voltage before connecting the power cord to an outlet.

This machine must be connected to an electrically ground circuit in order to protect the operator from electric shock. This machine has an approved power cord with three conductors as well as a plug with three terminals. Connect the plug to a three holed receptacle. For maximum protection against electric shock, use a circuit that is protected by a ground fault circuit interrupter.

This machine uses a 120 volt AC 50/60 cycle electrical circuit. Make sure you have the correct frequency and voltage before connecting the power cord to an outlet. The machine has a plug as shown in Figure 5. If a receptacle connected to the electrical ground as shown in Figure 5 is not available, contact an electrical contractor. Do not use an adapter.

**⚠ WARNING:** To prevent possible electric shock, protect the machine from rain. Keep the machine in a dry building.

**⚠ WARNING:** To prevent possible electric shock, always use a 3-wire electrical system connected to the electrical ground. For maximum protection against electrical shock, use a circuit that is protected by a ground fault circuit interrupter. Consult your electrical contractor.

**⚠ WARNING:** Do not cut, remove, or break the ground pin. If the outlet does not fit the plug, consult your electrical contractor.

**⚠ WARNING:** If the cords or plugs are worn or damaged in any way, have them replaced by an authorized service person.

**Extension Cords**

Use only an approved extension cord with three conductors, a plug with three terminals and a three-holed connector body. This machine has a power cord with a wire size of 16 AWG. (AWG stands for American Wire Gauge).

**⚠ CAUTION:** If you use an extension cord, use one that has a minimum wire size of 14 AWG. Be sure your extension cord is no longer than 50 ft. Do not join two extension cords.

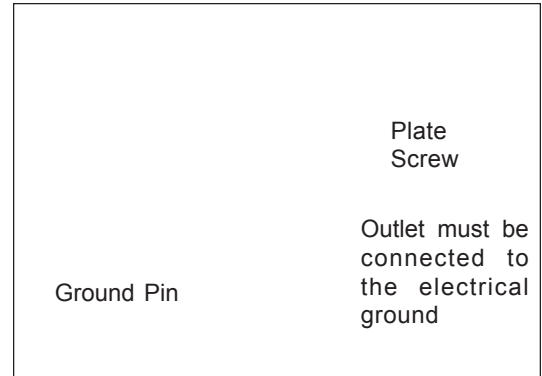

Figure 5



**INSTRUCTIONS FOR CONNECTION TO THE  
POWER SUPPLY AND ELECTRICAL GROUND - 230 V**

**⚠ CAUTION:** This machine will operate only on an AC frequency and on the specified electrical voltage shown on the nameplate. Make sure you have the correct frequency and voltage before connecting the power cord to an outlet.

This machine must be connected to an electrical ground circuit in order to protect the operator from electric shock. This machine has an approved power cord with two main conductors and one earthing conductor. Connect the plug to the type of receptacle shown in figure 6. The green and yellow conductor in the cord is the ground wire. Never connect this wire to any terminal other than the ground terminal.

**⚠ WARNING:** Always use this machine with an AC three-conductor electrical system connected to the electrical ground. Replace any worn, cut or damaged cords. Replace any damaged plugs, receptacles, or connector bodies. Do not move the machine over an electrical cord. Always lift the cord over the machine.

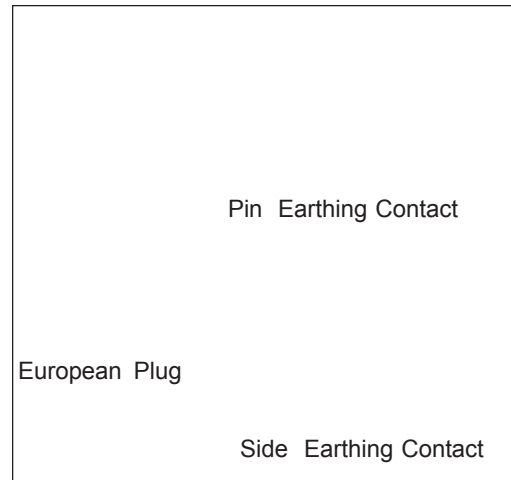

Figure 6

**Extension Cords**

Use only an approved extension cord with two main conductors, and one earthing conductor. This machine has a power cord with a wire size of 1.5mm<sup>2</sup>.

**⚠ WARNING:** If you use an extension cord, use one that has a minimum wire size of 1.5mm<sup>2</sup>. Be sure your extension cord is no longer than 15 meters. Do not join two extension cords.

**⚠ WARNING:** Do not cut, remove or break the ground terminal. Do not try to fit a three-terminal plug into a receptacle or connector body that does not fit the plug. If the receptacle or connector body does not fit the plug, see your authorized Clarke Dealer to get an authorized person to make the connection.

### How to Clean an Area of Carpet See Figure 7

 **WARNING:** Do not use water that is hotter than 140°F (60°C).

To clean an area of carpet, follow this procedure:

1. Start the pump for the solution and the motor for the vacuum on the extractor.
2. Begin at the right-hand corner of the carpet.
3. Hold the floor tool at the angle that gives the best vacuum seal between the tool and the carpet.
4. Apply pressure to the lever for solution release. Pull the tool toward you at a slow, steady speed. To remove as much solution as possible, release the lever before you stop moving backward.
5. To clean the edge of a room, move the tool along the baseboard until the edge of all the carpet is cleaned.
6. To clean a small area of carpet, clean the carpet in sections three feet square. As you make more passes, repeat one inch of the area already cleaned.
7. To remove more liquid from the carpet, make passes over the area already cleaned, but do not apply pressure to the lever for the solution.

Figure 7

### How To Clean A Larger Area Of Carpet See Fig. 8

To clean a larger area of carpet, follow this procedure:

1. Begin at the right-hand corner of the carpet.
2. Make a pass halfway along the edge of the carpet. Pull the tool backward at a steady speed.
3. Move to the edge of the carpet. Make another pass next to your first pass.
4. As you make more passes, repeat one inch of the area already cleaned. If you use a power brush tool, repeat one inch of the area already cleaned by the brush. Make each pass four inches different in length to prevent making a line in the center of the carpet.
5. Make more passes until half of the carpet is cleaned. To remove more liquid from the carpet, make passes over the area already cleaned, but do not apply pressure to the lever for the solution.
6. Move to the right-hand corner of the part of the carpet not yet cleaned.
7. Make a pass halfway along the edge of the carpet.
8. As you make passes, repeat one inch of the area already cleaned.
9. Make more passes until all of the room is cleaned.

Figure 8

 **CAUTION:** Clarke will not be held liable for damage to the carpet, or poor results because of the operator's lack of ability.

**⚠ WARNING:** Maintenance and repairs must be done by authorized personnel only. Keep all fasteners tight. Use only genuine Clarke parts.

**⚠ WARNING:** Do not operate this machine unless it is completely assembled.

**NOTE:** For maintenance of the floor tools or power brush tools, read the manual given with the tools.

### **After Each Use of the Machine**

1. To remove unused cleaning solution from the solution tank, put the end of the vacuum hose in the solution tank. Start the vacuum motor. Stop the motor when the tank is empty.
2. To prevent damage to the valves and jets, flush one gallon of clean water through the solution system and the tools.
3. Disconnect the power cord from the outlet.
4. Remove the recovery tank cover.
5. Lift the pail and discard the solution.
6. Rinse the pail with clean water.
7. Use a dry cloth to wipe the tools and both tanks, inside and out.
8. Apply a small amount of silicone lubricant to the quick-disconnect fittings. To prevent damage to the O-rings, do not use an oil lubricant.
9. Clean and inspect the gasket on the vacuum shut-off valve. If the gasket is damaged, replace the gasket.
10. Inspect and clean the filter screen in the bottom of the solution tank. See figure 9. To remove the filter screen, turn the filter counterclockwise. To



Figure 9

## MAINTENANCE (CONT)

### How To Prevent Damage From Freezing Temperatures

To prevent damage from freezing temperatures follow this procedure:

1. Use the vacuum hose to remove all the solution from the clean solution tank.
2. Connect the solution hose to the extractor and a floor tool.
3. Put approximately 1 quart of antifreeze solution in the solution tank.
4. Put the switch for the pump in the "I" position.
5. Put the end of the floor tool in the recovery pail.
6. Press the lever on the floor tool to activate the pump.
7. Make sure the solution runs through the system.
8. Release the lever on the floor tool to stop the pump.
9. Flush the antifreeze solution from the system before using the extractor.

 **WARNING:** Electrical repairs must be done by authorized personnel only.

 **WARNING:** After electrical repairs are done to the machine, the machine must be tested for electrical safety.

### How To Get Access To The Pump and Vacuum Motor

To get access to the pump and the vacuum motor, follow this procedure:

1. Remove the dome.
2. Empty both tanks.
3. Remove the pail.
4. Remove the ten screws from the lower housing (1).
5. Lift the upper housing from the machine (2). See figure 10.

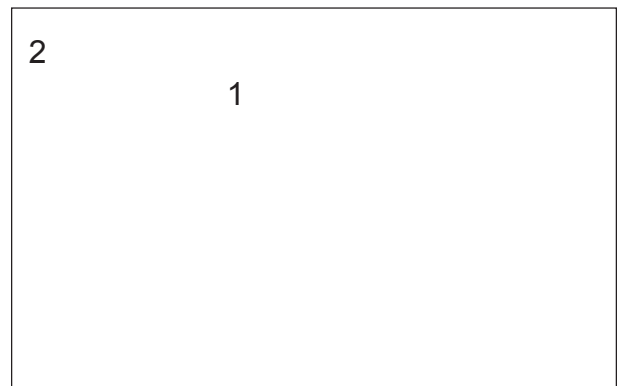

Figure 10

## **Maintenance Of The Motor**

This machine has a vacuum motor that uses carbon brushes. The carbon brushes in the motor must be checked every three months, or every 500 hours of operation, whichever comes first. If either of the brushes is shorter than 3/8 inch, replace both of the carbon brushes.

### **How To Check The Commutator And The Carbon Brushes**



**WARNING:** Electrical inspections must be made by a person authorized to make electrical repairs.

To check the commutator and the carbon brushes follow this procedure:

1. Disconnect the power cord from the electrical outlet.
2. Remove the dome.
3. Empty both tanks.
4. Remove the pail.
5. Remove the ten screws from the lower housing.
6. Lift the upper housing from the lower housing.
7. Put the machine on its side.
8. Disconnect the ground wire.
9. Remove the two screws from the bottom of the machine that hold the motor bracket.
10. Remove the plastic motor cover.
11. Inspect the commutator. See figure 11. Take the machine to a Clarke authorized repair location if you see any of the following conditions:
  - a. Small holes in the surface of the commutator. See "A" in figure 11.
  - b. Uneven color. Look for an even dark brown color. Clean areas or very dark areas indicate a problem. See "B" in figure 11.
  - c. High mica. The mica insulation must be lower than the commutator bars. See "C" in figure 11.
12. To check the carbon brush assemblies, remove the two screws from the holding bracket.
13. Remove the brackets.
14. Remove the carbon brush assemblies.
15. Check the carbon brush assembly. Replace both carbon brush assemblies if either carbon brush is shorter than 3/8 inch. If either brush is shorter than 1/2 inch, order replacement brushes. Be ready to replace both carbon brushes earlier than the normal inspection time.
16. Put the motor brushes in position.
17. Using the two screws, install the bracket that holds the carbon brushes.
18. Install the plastic motor cover.
19. Connect the ground wire.
20. Install the motor holding bracket.
21. Install the lower housing to the upper housing.

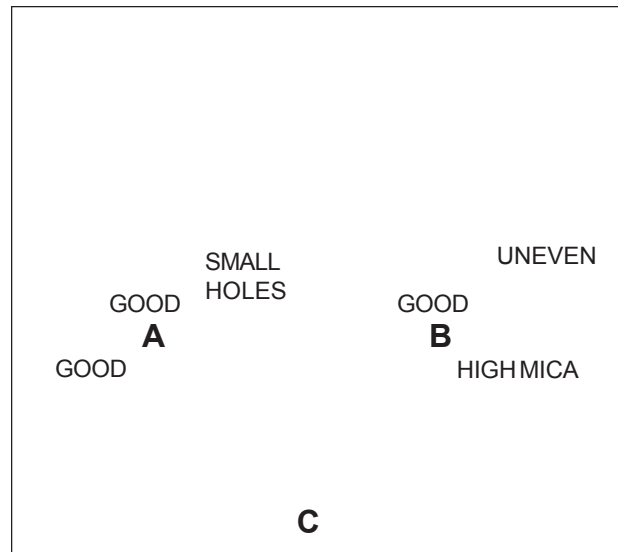

Figure 11

## HOW TO CORRECT PROBLEMS IN THE MACHINE

Problem	Cause	Action
<b>The machine will not run.</b>	1. The machine has no power.	1. Make sure the machine is connected to the correct frequency and voltage, and all connections are tight.  Make sure the plug is in the electrical outlet.
	2. The power cord is damaged.	2. Contact an authorized service person to replace the cord.
<b>There is no suction.</b>	1. The vac motor does not run.	1. Put the switch for the vacuum in the "I" position.
	2. The vac motor switch is defective.	2. Contact an authorized service person.
	3. There is a loose motor connection.	3. Contact an authorized service person.
	4. There is an obstruction in the vacuum hose.	4. Remove the obstruction.
	5. The recovery tank is full.	5. Remove the liquid from the tank.
	6. The dome gasket is worn or damaged.	6. Contact an authorized service person to replace gasket.
	7. The dome is not in the correct position.	7. Put the dome in the correct position.
	8. The internal vac hose is damaged or stopped.	8. Contact an authorized service person.
	9. The dome is damaged.	9. Replace the dome.
	10. The motor brushes are worn.	10. Replace the motor brushes.
	11. A wrong size pail is being used.	11. Use only the pail given with the machine.
<b>There is no pressure.</b>	1. The switch is in the "OFF" position.	1. Put the switch in the "I" position.
	2. The pressure switch is damaged.	2. Contact an authorized service person.
	3. The pump motor will not run.	3. Contact an authorized service person.
	4. The pump motor brushes are worn.	4. Contact an authorized service person.
	5. The quick disconnect fitting is dirty or stopped.	5. Contact an authorized service person.
	6. The solution hose is bent.	6. Straighten the hose. Replace if damaged.
	7. The pump is worn.	7. Contact an authorized service person.
	8. The pump switch is defective.	8. Contact an authorized service person.
	9. The pump connections are loose.	9. Contact an authorized service person.
	10. The pump intake and outlet valves are worn.	10. Contact an authorized service person.
	11. The thermo protector is open.	11. Contact an authorized service person.
	12. The solution tank is empty.	12. Fill the solution tank.
	13. The intake screen is dirty.	13. Clean the screen.
	14. The rectifier in the pump motor is bad.	14. Contact an authorized service person.
<b>The solution tank leaks.</b>	1. The intake gasket is worn.	1. Contact an authorized service person.
	2. The tank is damaged.	2. Contact an authorized service person.
<b>The recovery tank overflows.</b>	1. The float is dirty or damaged.	1. Clean the float. Replace if damaged.
	2. There is too much foam.	2. Put defoamer in the solution. Order P/N 398420.
	3. The float gasket is dirty or damaged.	3. Clean the gasket. Replace if damaged.

**Clarke® EXT-311**  
**Machine Variables and Accessories 1/00**

Variable Code			
<b>04090A</b>	Breakdown:	04090A	EXT 311 Base 120V
<b>04091A</b>	Breakdown:	04090A 59230A	EXT 311 Base 120V 8" Plastic Wand Floor Tool
<b>04092A</b>	Breakdown:	04090A 59229A	EXT 311 Base 120V 12" Metal Floor Tool
<b>04093A</b>	Breakdown:	04090A 04016A	EXT 311 Base 120V PB-12 Power Brush 120V
<b>04095A</b>	Breakdown:	04095A	EXT 311 Base 230V
<b>04096A</b>	Breakdown:	04095A 59230A	EXT-311 Base 230V 8" Plastic Wand Floor Tool
<b>04097A</b>	Breakdown:	04095A 59229A	EXT-311 Base 230V 12" Metal Floor Tool
<b>04098A</b>	Breakdown:	04095A 04017A	EXT-311 Base 230V PB-12 Power Brush 230V

**ACCESSORIES**

<b>Descriptions</b>	<b>Part No.</b>
Clarkare® Concentrate - case (4-1 gal.)	398425
Defoamer - case (4-1 gal.)	398426
Traffic Lane Spotter - case (4-1 gal.)	398427
Upkeep Shampoo - case (4-1 gal.)	398430
Carpet Dryer Standard	04128A
Carpet Dryer Deluxe	04130A
4" Metal Hand Tool	59228A
4" Plastic Hand Tool	59231A
4" Hand Tool & Hose Assembly	55173A
8" Plastic Wand Floor Tool	59230A
12" Metal Floor Tool	59229A
PB - 12 Power Brush 12"	04016B
10' Vac-Solution Hose Assembly	59232A
20' Vac-Solution Hose Assembly	55183A
1½ to 1½" Coupler	682408

---

**Clarke<sup>®</sup>**

Division of

**EXT 311**  
**Extractor**  
Section II  
**Parts and Service Manual**

(70471A)



Clarke® EXT-311  
Assembly Drawing 2/99

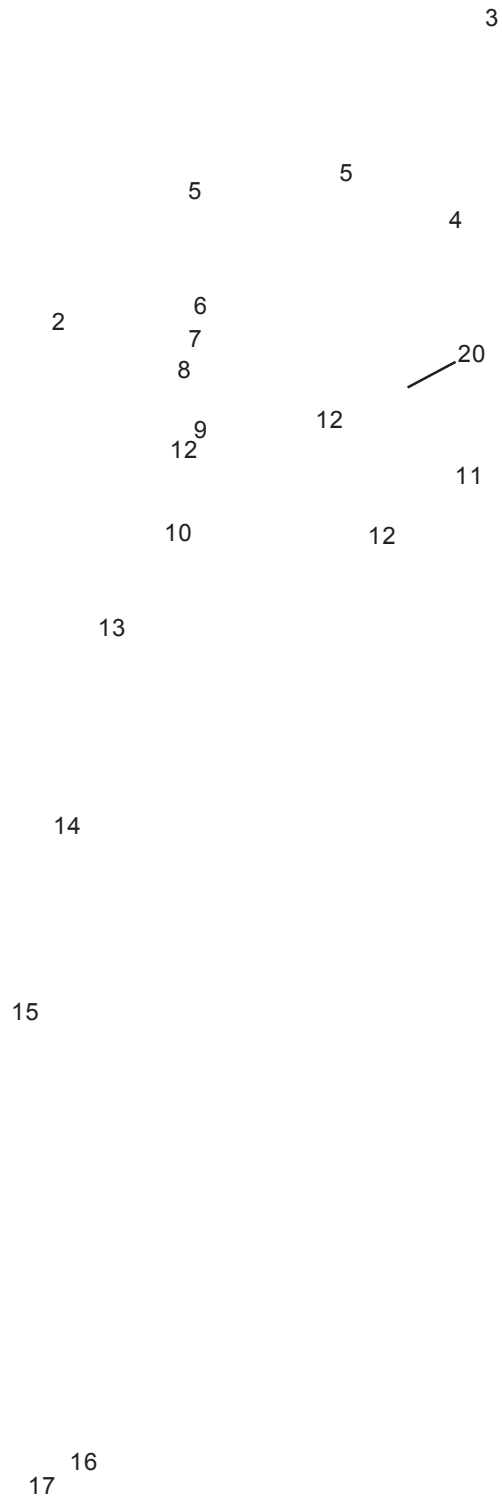

**Clarke® EXT-311**  
**Assembly Drawing Parts List 2/99**

Item #	Part No.	Description	Qty.
1	Pgs 16/17	Assembly, Base	1
2	73289B	Label, Warning	1
3	73290A	Label, Instruction	1
4	32504C	Dome, Recovery	1
5	962027	Screw, #8-32 x ½ Pan	2
6	85350A	Screw, #8-32 x 2½ Pan	2
7	62401A	Clamp, Float	1
8	33801A	Float	1
9	61110B	Bracket, Float	1
10	34213A	Gasket, Float Shut-off	1
11	67104A	Rod, Float Pivot	1
12	81109A	Nut, #8-32 ESNA S.S.	4
13	36901A	Pail, Recovery	1
14	34235B	Gasket, Dome Assembly	1
15	Page 18	Asm. Solution Tank	1
16	980982	Washer #10	10
17	85500A	Screw #10-32½	10
18	Page 16	Hose from Vac Motor	Ref.
19	Page 16	Clamp, Hose	Ref.
20	69431A	Bracket, Tank	1
Ref.	13001C	Dome & Label Assembly (Includes Items 2,3,4)	1
NI	699203	Tag, Caution	1

Clarke® EXT-311  
Base Assembly Drawing 11/02

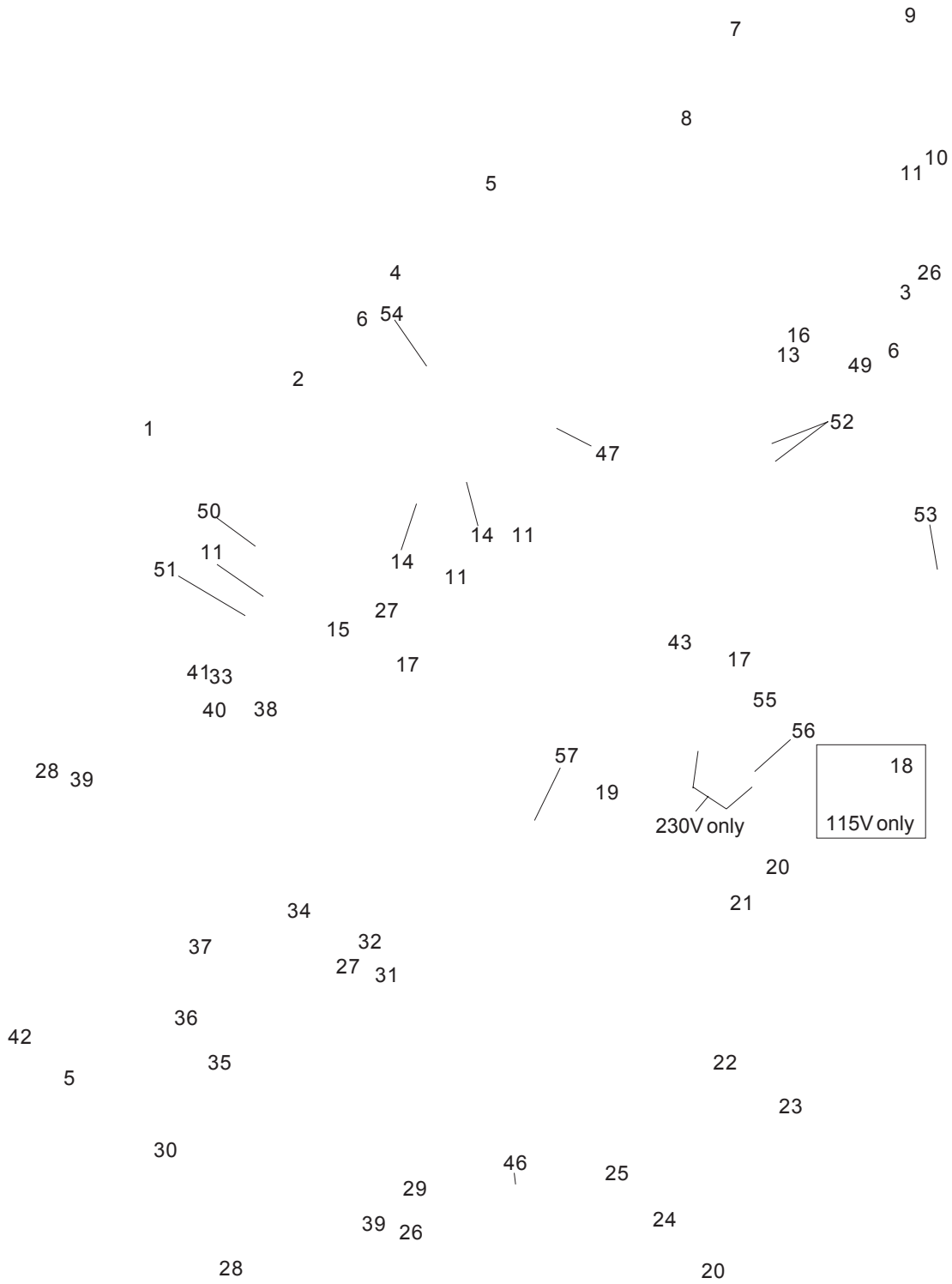

**Clarke® EXT-311**  
**Base Assembly Drawing Parts List 11/02**

Item #	Part No.	Description	Qty.
1	35131A	Hose, Vac to Tank	1
2	752020	Clamp, Hose	2
3	980646	Washer	3
4	65903A	Mount, Vac Motor	1
5	47711A	Terminal, ¼ FIFQDC	2
6	699202	Tie, Nylon	2
7	954010	Wire, Assembly Green	1
8	49739A	Harness, Control	Ref.
9	34234A	Gasket, Intake Air	1
10	962546	Screw, 10-24 x ½	1
11	980603	Washer #10 SH	3
13	58534A	Spacer	3
14	920234	Nut	2
15	66617A	Plate, Q.D. Mounting	1
16	44923A	Motor, Vac 120V	1
	44924A	Motor, Vac 230V	1
17	50248A	Clamp, Hose	2
18	692870	Elbow, (115V)	1
19	66633A	Plate, Nut	4
20	930074	Rivet, ⅛ Dia. Closed	6
21	603801	Grill, Housing	1
22	66634A	Plate, Label Mounting	1
23		Label, Serial No.	1
24	42214A	Cord, 120V 35'	1
	42231A	Cord, 230V 10m	1
25	52100A	Caster, 2" Ball	4
26	962950	Screw	3
27	920200	Nut, 10-24 Hex (115V only)	4
	920200	Nut, 10-24 Hex (230V only)	5

Item #	Part No.	Description	Qty.
28	962109	Screw, 10-24 x 5/8 115V	4
	962109	Screw, 10-24 x 5/8 230V	5
29	980646	Washer ¼ Plain	5
30	30321A	Base (Rotomold)	1
31	38002A	Strain Relief	1
32	964003	Screw, 5.0 x .8 x 20 PN*ST	2
33	980645	Washer, 13/32 I.D. x 13/16 O.D.	3
34	672012	Clamp, Cord	1
35	670811	Bracket, Strain Relief	1
36	672011	Clamp, Strain Relief	1
37	964005	Screw 5.0 x 0.8 x 16 PN*ST	2
38	50300A	Adapter, ⅛ NPT to 3/8 Hose	1
39	980982	Washer, #10 Plain Flat	4
40	725729	Nipple ⅛ Close Pipe	1
41	737140	Quick Disconnect	1
42	170687	Terminal, #10 Ring	1
43	35147A	Hose, 3/8 x 14"	1
46	962823	Screw, (115V only)	12
	962983	Screw, (230V only)	6
47	962113	Screw 10-32 x 1	1
49	47712A	Terminal, ¼ FIFQD	2
50	47201A	Filter (CE only)	1
51	962333	Screw (CE only)	6
52	49310A	Lead Assembly (CE only)	2
53	49642B	Harness, Grounding (CE only)	1
54	77094A	Label, Ground Symbol (CE only)	1
55	170028	Hose barb (230V only)	2
56	170039	Elbow (230V only)	2

**Clarke® EXT-311**  
**Solution Tank Assembly Drawing & Parts List 11/02**

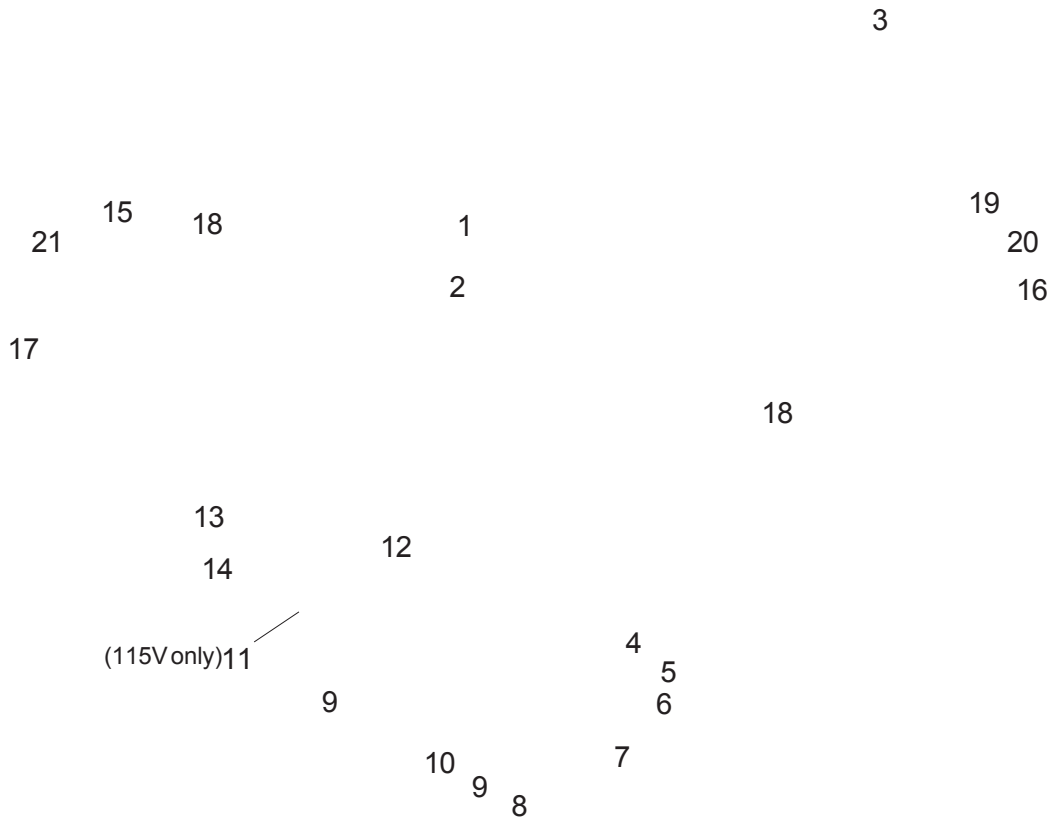

Item #	Part No.	Description	Qty.
1	728535	Strainer	1
2	60306A	Adapter, Filter	1
3	30319A	Tank	1
4	833401	Gasket, Drain	1
5	980630	Washer, <sup>3</sup> / <sub>4</sub> " Plain	1
6	920264	Nut, <sup>3</sup> / <sub>4</sub> -16	1
7	170040	Elbow, St. <sup>1</sup> / <sub>4</sub> NPT	1
8	170030	Hosebarb, <sup>3</sup> / <sub>8</sub> " x <sup>1</sup> / <sub>4</sub> " NPT	1
9	50248A	Clamp, Hose	2
10	35147A	Hose, <sup>3</sup> / <sub>8</sub> " x 14"	1
11	692870	Elbow (115V)	1
NI	170039	Elbow (230V) See pg 16	1

Item #	Part No.	Description	Qty.
12	45928A	Pump 120V	1
	697011	Pump 230V	1
13	980982	Washer, #10	4
14	962113	Screw, 10-32 x 1	4
15	47711A	Terminal, <sup>1</sup> / <sub>4</sub> FIFQD (115V )	1
16	47316B	Switch, Rocker DPST	2
17	912064	Terminal, Clip #10	1
18	49739A	Harness Control	1
19	37303A	Switch, Plate	1
20	962929	Screw, 10-32 x <sup>3</sup> / <sub>8</sub>	4
21	47905A	Terminal, <sup>1</sup> / <sub>4</sub> FIMQD (230V)	1
NI	699202	Tie, Cable	1

Clarke® EXT- 311  
10 Ft. Hose Assembly Drawing  
Part #59232A 11/98

1



Item #	Part No.	Description	Qty.
1	59232A	Hose, Pumper 1.5" I.D. x 10'L	1

**Clarke® EXT-311  
Pump (#45928A) 100 PSI/120V  
Drawing and Parts List - 11/98**

Ref #	Part No.	Description	Qty	45909B	45928A	45929A
1	55379A	Kit, Switch - Viton 60 psi	1	x		
	53057A	Kit, Switch - Viton 80/100 psi	1		x	
	53056A	Kit, Switch 80/100 psi	1			x
2	55374A	Kit, Dual Check Valves	1	x	x	
	52908A	Kit, Check Valves	1			x
3	54715A	Housing, Upper	1	x		
	54881A	Housing, Upper	1		x	x
4	55373A	Kit, Vavle	1	x		
	59783A	Kit, Valve	1		x	x
5	53201A	Kit, Diaphragm	1	x		
	53205A	Kit, Diaphragm	1		x	x
6	54888A	Housing, Lower	1	x		
	54882A	Housing, Lower	1		x	x
7	54837A	Kit, Drive Assembly	1	x		
	52909A	Kit, Drive Assembly	1		x	
	52907A	Kit, Drive Assembly	1			x





**Clarke® EXT-311**  
**Motor 230V #44924A - 11/98**

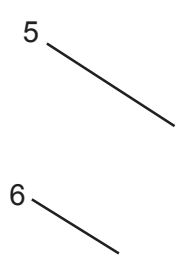
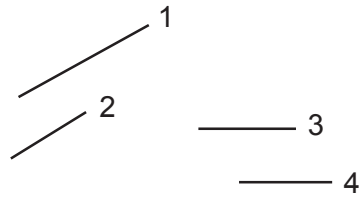

Ref #	Part No.	Description	Qty
1	53905A	Fan	1
2	50618A	Comm End Bracket	1
3	51914A	Clamp	2
4	40813A	Brush Mechanism	2
5	53995A	Air Seal Fan	1
6	53908A	Stationary Fan	1

Clarke® EXT-311  
 Connection Diagram 120V - 9/95

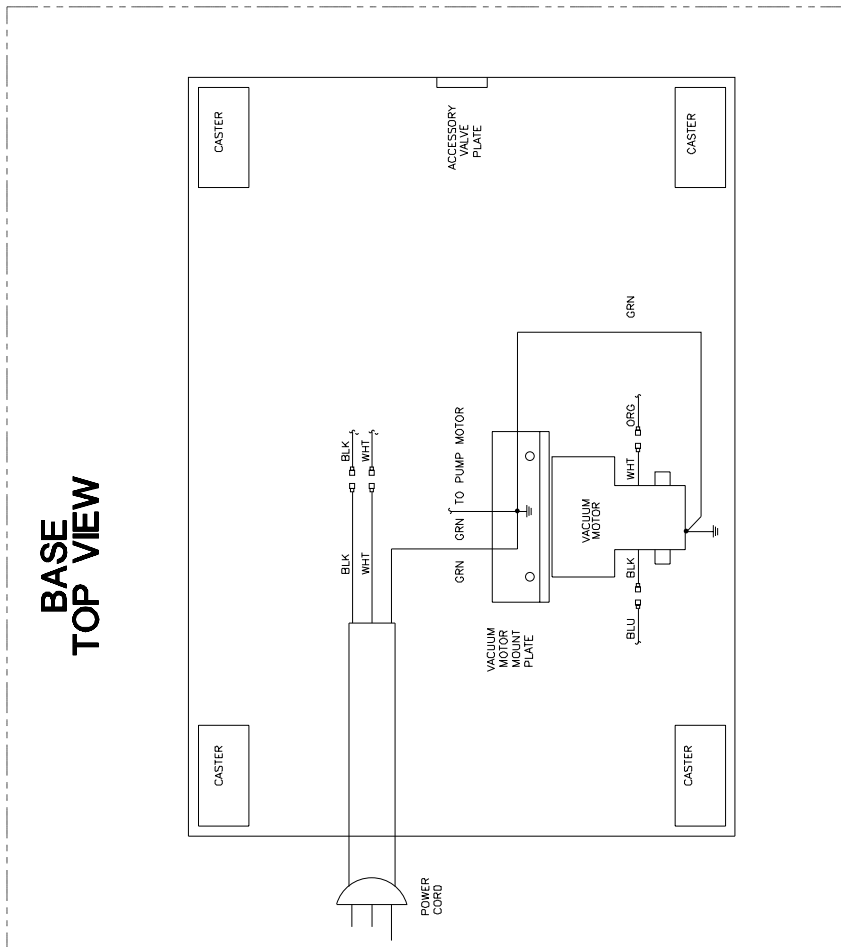
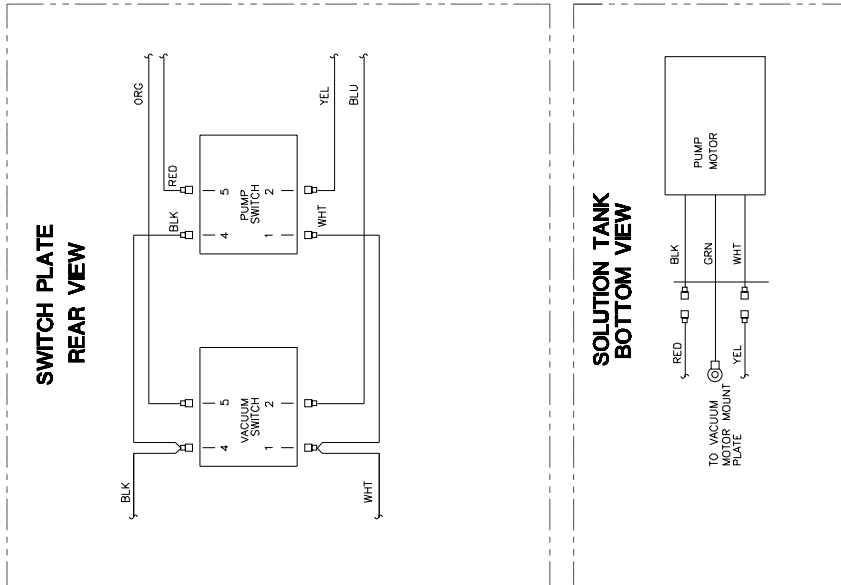

**Clarke® EXT-311  
Wiring Diagram 120V - 9/95**

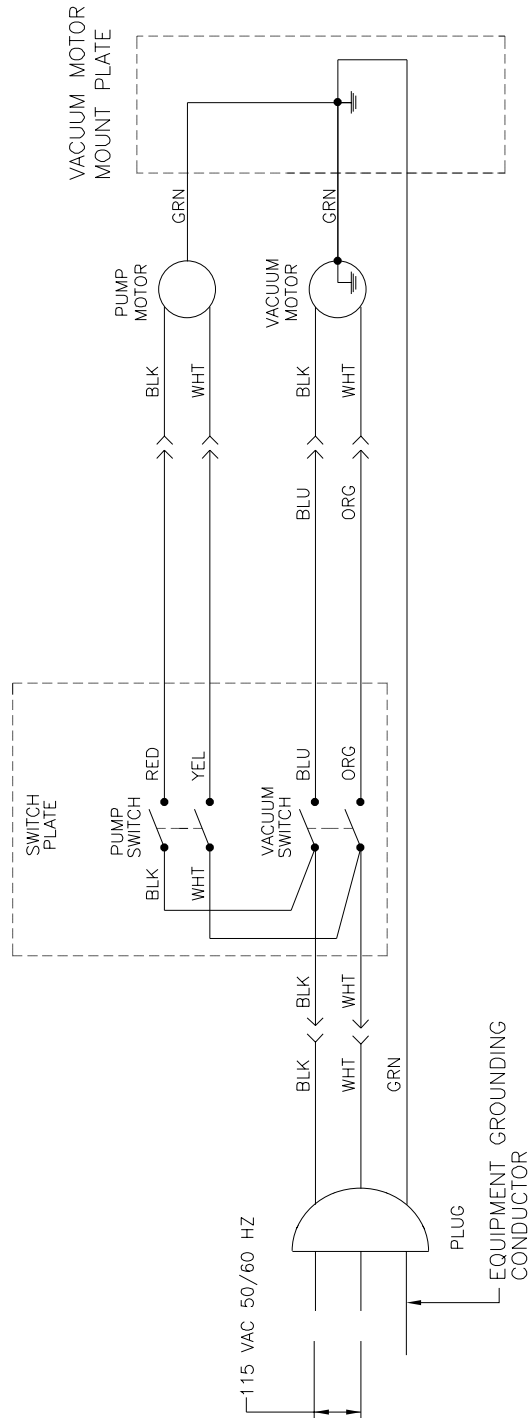

Clarke® EXT-311  
 Connection Diagram 230V - 9/98

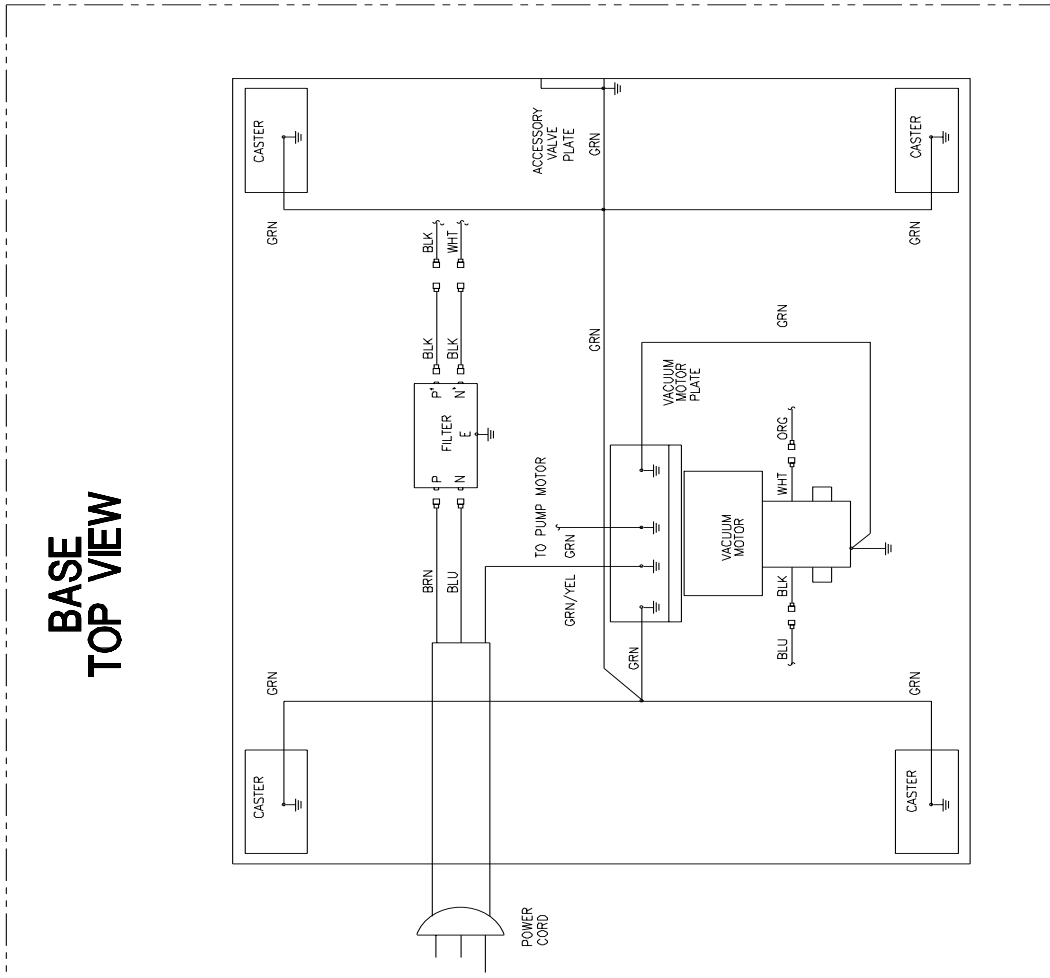
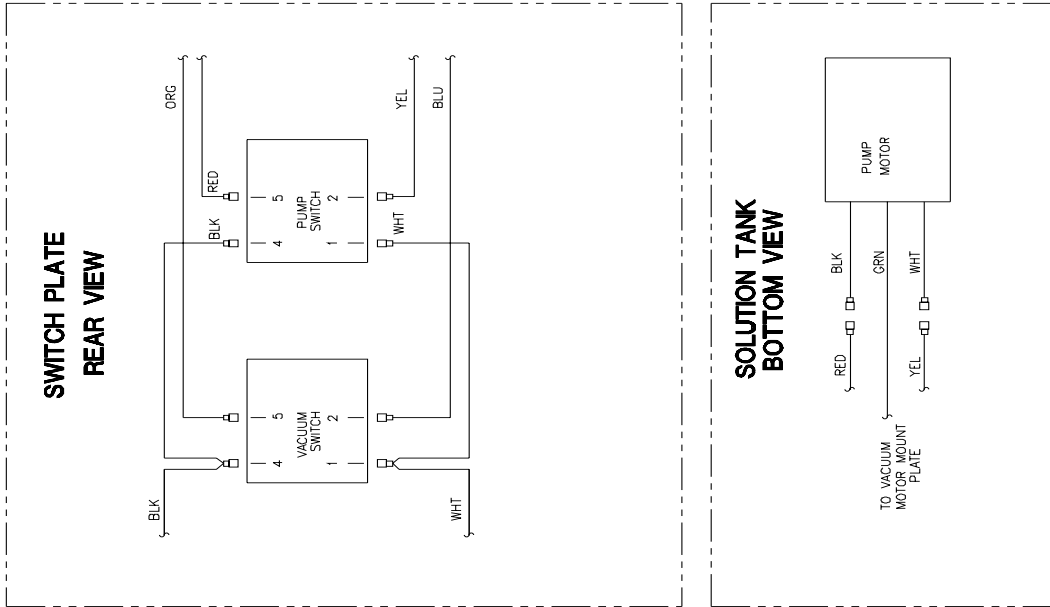

Clarke® EXT-311  
Wiring Diagram 230V - 9/98

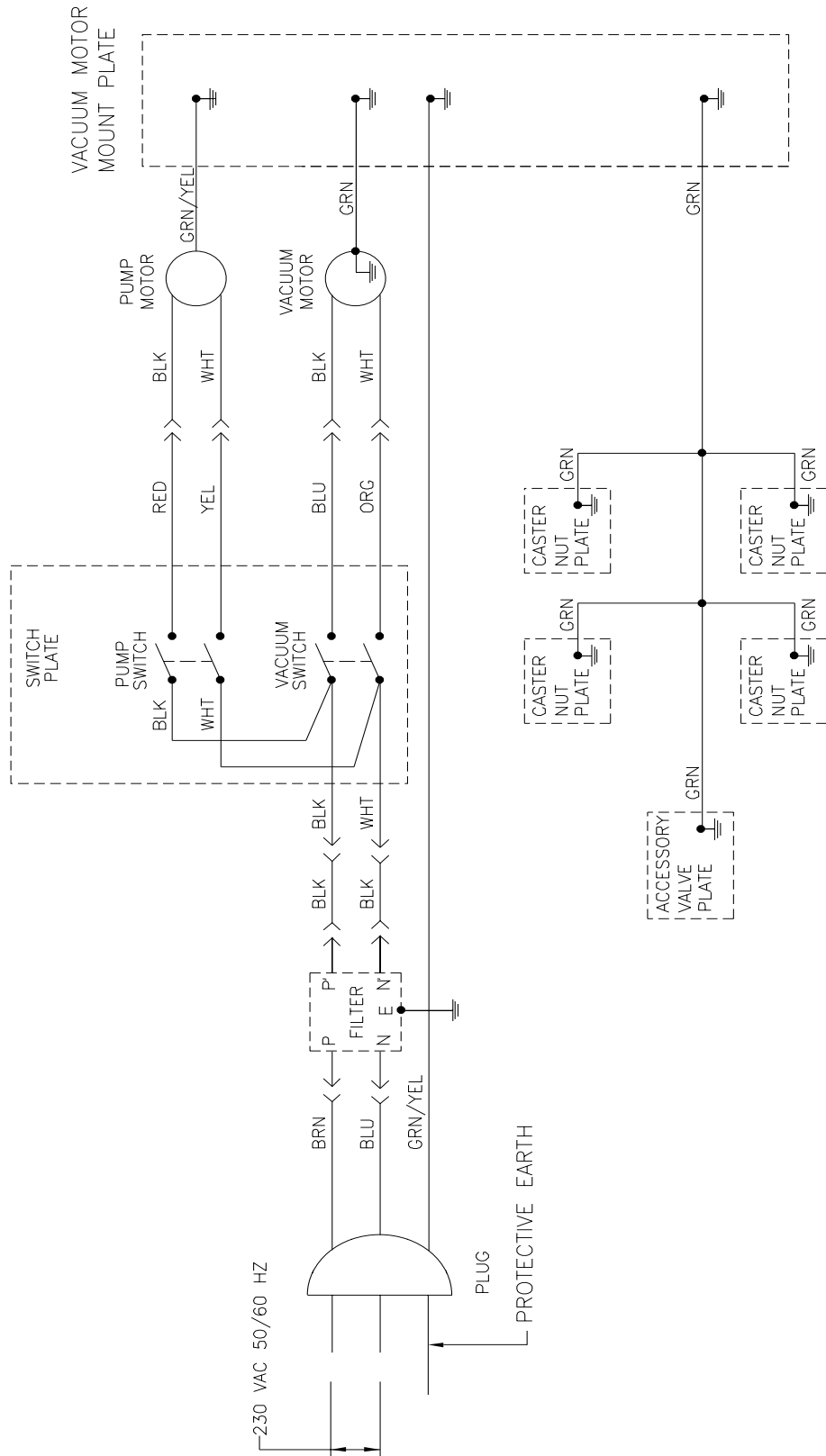

# PRODUCT SUPPORT BRANCHES

## U. S. A. Locations

### HEAD OFFICE

ALTO U.S. Inc., St. Louis, Missouri  
16253 Swingley Ridge Road, Suite 200  
Chesterfield, Missouri 63017-1725

### PRODUCTION FACILITIES

**Clarke®**, Springdale, Arkansas  
2100 Highway 265  
Springdale, Arkansas 72764  
(479) 750-1000  
**Customer Service - 1-800-253-0367**  
**Technical Service - 1-800-356-7274**

**American Lincoln®**, Bowling Green, Ohio 43402  
1100 Haskins Road

### SERVICE FACILITIES

**Clarke®**, Carlstadt, New Jersey 07072  
150 Commerce Road  
(201) 460-4774

**Clarke®**, Elk Grove, Illinois 60007  
2280 Elmhurst Road  
(847) 956-7900

**Clarke®**, Denver, Colorado 80204  
1955 West 13th Ave.  
(303) 623-4367

**Clarke®**, Houston, Texas 77040  
7215 North Gessner Road

### SALES AND SERVICE FACILITIES

**American Lincoln® / Clarke®**, Madison Heights,  
Michigan 48071-0158  
29815 John R.  
(810) 544-6300

**American Lincoln® / Clarke®**, Marietta, Georgia 30062  
1355 West Oak Common Lane  
(770) 973-5225

---

**Clarke®**  
**Clarke American Sanders**  
**A.L. Cook**  
**Customer Service Headquarters and Factory**  
2100 Highway 265  
Springdale, Arkansas 72764  
(479) 750-1000

**Technical Service**  
1-800-356-7274

## European Locations

### PRODUCTION FACILITIES

ALTO Danmark A/S, Aalborg  
Blytaekervej 2  
DK-9000 Aalborg  
+45 72 18 21 00

ALTO Danmark A/S, Hadsund  
Industrikvarteret  
DK-9560 Hadsund  
+45 72 18 21 00

### SALES SUBSIDIARIES

**Clarke®** Canada Ltd., Rexdale Ontario  
24 Constellation Ct.  
(416) 675-5830

ALTO Overseas Inc., Sydney (Australia)  
1B/8 Resolution Drive  
Caringbah NSW 2229  
+61 2 9524 6122

ALTO Cleaning Systems Asia Pte Ltd., Singapore  
No. 17 Link Road  
Singapore 619034  
+65 268 1006

ALTO Deutschland GmbH, Bellenberg (Germany)  
Guido-Oberdorfer-Straße 2-8  
89287 Bellenberg  
+49 0180 5 37 37 37

ALTO Cleaning Systems (UK) Ltd., Penrith  
Gilwilly Industrial Estate  
Penrith  
Cumbria CA11 9BN  
+44 1768 868 995

ALTO France S.A. Strasbourg  
B.P. 44, 4 Place d'Ostwald  
F-67036 Strasbourg  
Cedex 2  
+33 3 8828 8400

ALTO Nederland B.V. Vianen  
Stuartweg 4C  
NL-4131 NJ Vianen  
+31 347 324000

ALTO Sverige AB, Molndal (Sweden)  
Aminogatan 18  
Box 4029  
S-431 04 Molndal  
+46 31 706 73 00

ALTO Norge A/S, Oslo (Norway)  
Bjornerudveien 24  
N-1266  
+47 2275 1770

## **Clarke® LIMITED U.S. WARRANTY**

This Clarke Industrial/Commercial Product is warranted to be free from defects in materials and workmanship under normal use and service for a period of one year from the date of purchase, when operated and maintained in accordance with Clarke's Maintenance and Operations instructions.

This warranty is extended only to the original purchaser for use of the product. It does not cover normal wear parts such as electrical cable, rubber parts, hoses and motor brushes.

If a difficulty develops with the product you should:

- a) Contact the nearest authorized Clarke repair location or contact Clarke U.S. Inc. Service Operations Department, 2100 Highway 265, Springdale, Arkansas 72764, for the nearest authorized Clarke repair location. Only these locations are authorized to make repairs to the product under this warranty.
- b) Return the product to the nearest Clarke repair location. Transportation charges to and from the repair location must be prepaid by the purchaser.
- c) Clarke will repair the product and/or replace any defective parts without charge within a reasonable time after receipt of the product.

Clarke's liability under this warranty is limited to repair of the product and/or replacement of parts and is given to purchaser in lieu of all other remedies, including INCIDENTAL AND CONSEQUENTIAL DAMAGES.

THERE ARE NO EXPRESS WARRANTIES OTHER THAN THOSE SPECIFIED HEREIN. THERE ARE NO WARRANTIES WHICH EXTEND BEYOND THE DESCRIPTION OF THE FACE HEREOF. NO WARRANTIES, INCLUDING BUT NOT LIMITED TO WARRANTY OF MERCHANTABILITY, SHALL BE IMPLIED. A warranty registration card is provided with your Clarke product. Return the card to assist Clarke in providing the performance you expect from your new floor machine.

**Clarke®**, 2100 Highway 265, Springdale, Arkansas 72764.

**Clarke® reserves the right to make changes or improvements to its machine without notice.  
Always use genuine Clarke® Parts for repair.**

Division of

**2100 Highway 265  
Springdale, Arkansas, 72764**

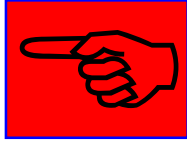

# ALTO<sup>®</sup>

**CLARKE**  
**TECHNOLOGY**

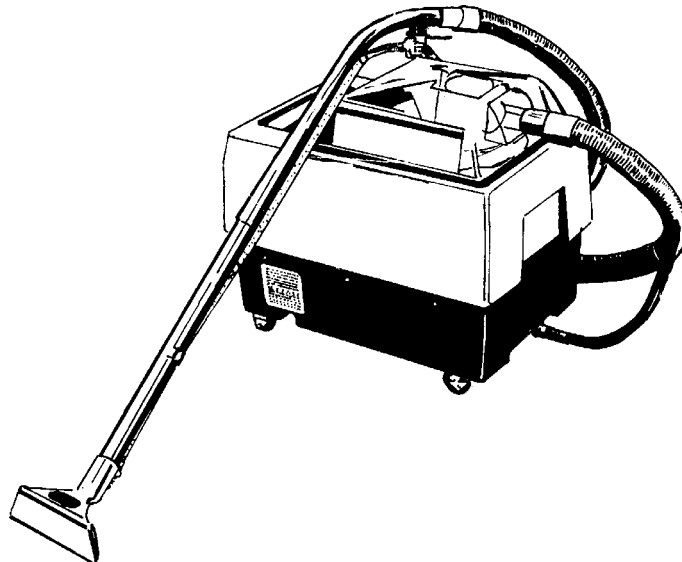

## **EXT 515** **Extractor**

### **READ THIS BOOK**

This book has important information for the use and safe operation of this machine. Failure to read this book prior to operating or attempting any service or maintenance procedure to your Clarke machine could result in injury to you or to other personnel; damage to the machine or to other property could occur as well. You must have training in the operation of this machine before using it. If your operator(s) cannot read English, have this manual explained fully before attempting to operate this machine.

Si Ud. o sus operadores no pueden leer el Inglés, se hagan explicar este manual completamente antes de tratar el manejo o servicio de esta máquina.

All directions given in this book are as seen from the operator's position at the rear of the machine.

For new books write to: ALTO U.S. Inc., 2100 Highway 265, Springdale, Arkansas 72764.



## CONTENTS OF THIS BOOK

Operator Safety Instructions .....	3
Introduction and Machine Specifications .....	4
Controls and Machine Features .....	5
How to Prepare the Machine for Operation .....	6
Instructions for Connection to the Power Supply - 115V Extension Cords - 120V .....	7
Instructions for Connection to the Power Supply - 230V Extension Cords - 230V .....	8
Machine Operating Instructions .....	9
How to Clean an Area of Carpet .....	9
How To clean a Larger Area of Carpet .....	9
Maintenance .....	10
After Each Use of the Machine .....	10
How to Prevent Damage from Freezing Temperatures .....	11
The Pump and Vacuum Motor .....	11
How To Check The Commutator and The Carbon Brushes .....	12
How to Correct Problems in the Machine .....	13
Assembly Drawing #1 .....	16
Parts List .....	17
Assembly Drawing #2 and Parts List .....	18
Hose Assembly Drawing & Parts List .....	19
Pump Drawing & Parts List .....	20
Motor Drawing & Parts List 120V .....	21
Motor Drawing & Parts List 230V .....	22
Wiring Diagrams .....	23

## OPERATOR SAFETY INSTRUCTIONS



**WARNING**





**AVERTISSEMENT**





**ADVERTENCIA**

For the safe operation of this machine, read and understand all warnings and cautions.

 **DANGER** means: Severe bodily injury or death can occur to you or other personnel if the **DANGER** statements found on your machine or in your Owner's Manual are ignored or are not adhered to. Read and observe all **DANGER** statements found in your Owner's Manual and on your machine.

 **WARNING** means: Injury can occur to you or to other personnel if the **WARNING** statements found on your machine or in your Owner's Manual are ignored or are not adhered to. Read and observe all **WARNING** statements found in your Owner's Manual and on your machine.

 **CAUTION** means: Damage can occur to the machine or to other property if the **CAUTION** statements found on your machine or in your Owner's Manual are ignored or not adhered to. Read and observe all **CAUTION** statements found in your Owner's Manual and on your machine.

 **DANGER:** Machines can cause an explosion when operated near flammable materials and vapors. Do not use this machine with or near fuels, grain dust, solvents, thinners, or other flammable materials.

 **DANGER:** Do not immerse. To reduce the risk of an electric shock, use only on a carpet that has been moistened by a cleaning process. Protect the machine from rain. Keep the machine in a dry building. Always clean the machine with a clean dry cloth.

 **WARNING:** You must have training in the operation of this machine before using it. **READ THE OPERATOR'S MANUAL FIRST.**

 **WARNING:** Always use a three-wire electrical system connected to the electrical ground. For maximum protection against electric shock, use a circuit that is protected by a ground fault circuit interrupter. Consult your electrical contractor.

 **WARNING:** To prevent electric shock, always remove the electrical plug from the electrical outlet before doing any repairs or maintenance to this machine.

 **WARNING:** Do not use this machine as a step or furniture. Injury could occur to the operator.

 **WARNING:** To avoid serious injury, use proper lifting procedures when lifting the machine.



 **WARNING:** Maintenance and repairs must be done by authorized personnel only.

 **WARNING:** Keep all fasteners tight. Keep the adjustments according to specifications.

 **WARNING:** Make sure that all the labels, decals, warnings, cautions and instructions are fastened to the machine. Replace them when necessary by ordering them from ALTO U.S..

 **WARNING:** Do not use water that is hotter than 140°F.

## OPERATOR SAFETY INSTRUCTIONS (CONT.)

-  **WARNING:** Improper discharge of waste water may damage the environment and be illegal. The United States Environmental Protection Agency has established certain regulations regarding discharge of waste water. Also, city and state regulation regarding this discharge may be in effect in your area. Understand and follow the regulations in your area. Be aware of the environmental hazards of chemicals that you dispose.
-  **CAUTION:** To prevent damage to the power cord, do not move this machine over the power cord, instead, lift the power cord over the machine.
-  **CAUTION:** To prevent damage to the power cord and hoses, do not use the power cord or hoses to pull the machine.

## INTRODUCTION

- The Model 515 is an extractor for cleaning carpet. When used with a floor tool, the machine applies cleaning solution to the carpet and removes the dirty solution and soil from the carpet.
- The extractor has controls to start the pump for the solution and the motor for the vacuum. The floor tools have controls to release the solution and to operate the brush.
- The extractor has a demand pump. The pump starts when the solution lever on the floor tool is activated. The pump stops when the lever is released.

**NOTE:** When using the extractor to clean carpets, follow this procedure:

1. Do not walk on freshly cleaned carpets for at least four hours or until the carpet is dry to touch.
2. Do not remove aluminum or plastic pieces that have been placed under the legs of furniture until the carpet is dry.
3. Do not allow children or pets to crawl or walk around on the damp carpet.
4. Vacuum right after the carpet is dry and then vacuum the carpet once a week as needed.

<b>Electrical</b>	120 V 50/60 Hz.
<b>Amps</b>	9 amps
<b>Solution Pump</b>	60 psi
<b>Solution Tank</b>	15 gal
<b>Recovery Tank</b>	5 gal
<b>Solution Flow</b>	1.47 GPM (Open Flow)
<b>Vacuum Motor</b>	2 hp
<b>Power Cable</b>	35', 3-wire grounded (10.7m)
<b>Wheels</b>	4 - 2" (5.1 cm)
<b>Dimensions</b>	25"L (63.5cm) x 17½"W (44.5cm) x 26¼"H (56.5cm)
<b>Weight</b>	45 lbs.
<b>Shipping Weight</b>	70 lbs.
<b>Warranty</b>	1 year
<b>Sound Level</b>	

**The Vacuum Motor Switch**

The vacuum motor switch is on the back of the machine. Put the switch in the "I" position to start the motor. Put the switch in the "O" position to stop the motor.

**The Switch To Activate The Pump**

The switch to start/stop the pump motor is on the back of the machine. Put the switch in the "I" position to start the pump motor. Press the lever on the floor tool to activate the pump. Release the levers on the floor to stop the pump. Put the switch in the "O" position to stop the pump motor.

**NOTE: While the machine is in operation, the pump will shut-off automatically when it reaches full pressure. The pump will automatically turn on when the pressure decreases.**

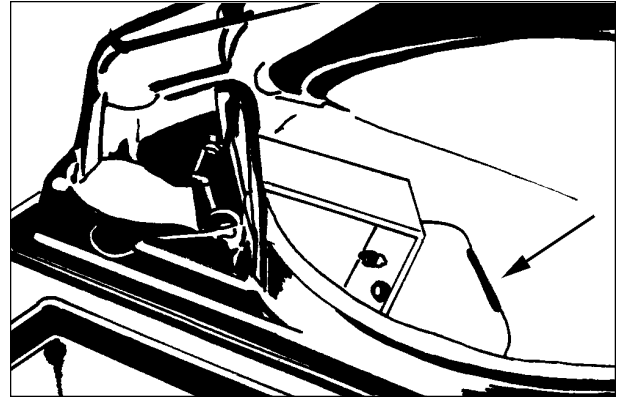

Figure 1

**The Float Shut-Off See figure 1**

The float shut-off is in the recovery tank. When the liquid raises the float, the air stops moving through the machine.

**The Vacuum Hose Connector See figure 2**

The vacuum hose connector is on the dome assembly.

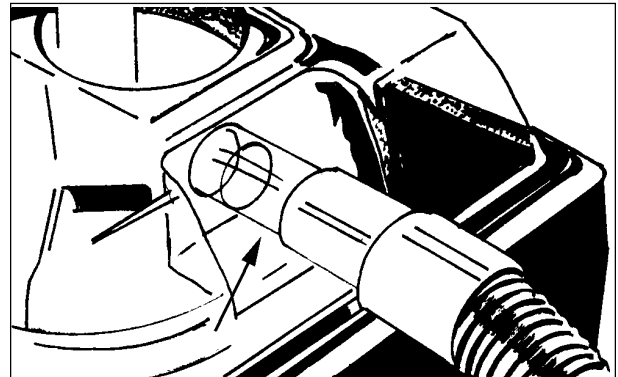

Figure 2

**The Solution Hose Connector See figure 3**

The solution hose connector is on the lower part of the extractor, below the vacuum hose connector.

**The Recovery Tank**

The recovery tank is in the top of the machine. Make sure the white pail is in the tank when the machine is running.

**The Solution Tank**

The solution tank is in the top of the machine next to the recovery tank.

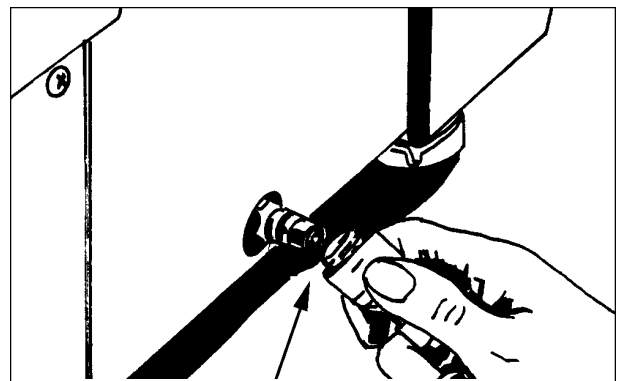

Figure 3

## HOW TO PREPARE THE MACHINE FOR OPERATION

To prepare the machine for operation, follow this procedure:

1. Connect the vacuum hose to the hose connector on the extractor and to the end of the vacuum tube on the floor tool.
2. Connect the solution hose to the extractor and the floor tool. To fasten the quick disconnect fitting, slide the knurled collar on the female coupling away from the opening. Push the male coupling into the female coupling. See figure 4

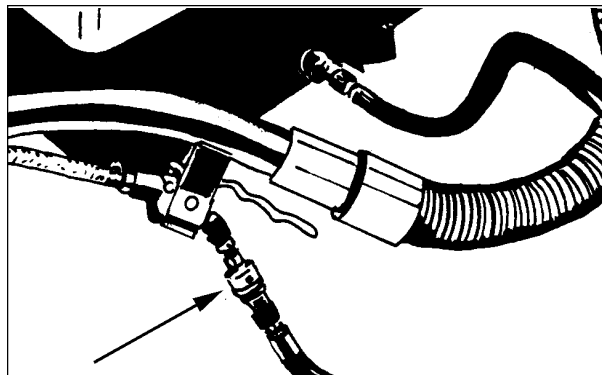

Figure 4

**WARNING:** Do not use water that is hotter than 140°F.

3. Before moving the extractor onto the carpet, put clean hot water into the solution tank.
4. Add a cleaning chemical, such as Clarkare® Extractor Concentrate, to the hot water. For the correct amount, follow the directions shown on the container.
5. If the extractor removes an excess amount of foam from the carpet, add a de-foamer such as Clarkare® De-foamer Concentrate to the recovery tank. The amount needed will vary according to the amount of detergent already in the carpet.

**CAUTION:** To prevent damage, use a water-based de-foamer rather than an oil-based de-foamer.

**CAUTION:** Do not leave the extractor or other cleaning machines or tools on the carpet when not in use. Cleaning solution in the machines and tools can leak onto the carpet and cause light spots or stains.

**NOTE:** To order Clarkare® Extractor Concentrate, order part no. 398421. To order Clarkare® Defoamer, order part no. 398420.

For instructions on preparation and operation of your floor tool or power brush tool, read the operator's manual given with your floor tool or power brush tool.

## INSTRUCTIONS FOR CONNECTION TO THE POWER SUPPLY AND ELECTRICAL GROUND - 120 V

**⚠ CAUTION:** This machine will operate only on an AC frequency and on the specified electrical voltage shown on the nameplate. Make sure you have the correct frequency and voltage before connecting the power cord to an outlet.

This machine must be connected to an electrically ground circuit in order to protect the operator from electric shock. This machine has an approved power cord with three conductors as well as a plug with three terminals. Connect the plug to a three holed receptacle. For maximum protection against electric shock, use a circuit that is protected by a ground fault circuit interrupter.

This machine uses a 120 volt AC 50/60 cycle electrical circuit. Make sure you have the correct frequency and voltage before connecting the power cord to an outlet. The machine has a plug as shown in Figure 5. If a receptacle connected to the electrical ground as shown in Figure 5 is not available, contact an electrical contractor. Do not use an adapter.

**⚠ WARNING:** To prevent possible electric shock, protect the machine from rain. Keep the machine in a dry building.

**⚠ WARNING:** To prevent possible electric shock, always use a 3-wire electrical system connected to the electrical ground. For maximum protection against electrical shock, use a circuit that is protected by a ground fault circuit interrupter. Consult your electrical contractor.

**⚠ WARNING:** Do not cut, remove, or break the ground pin. If the outlet does not fit the plug, consult your electrical contractor.

**⚠ WARNING:** If the cords or plugs are worn or damaged in any way, have them replaced by an authorized service person.

### Extension Cords

Use only an approved extension cord with three conductors, a plug with three terminals and a three-holed connector body. This machine has a power cord with a wire size of 16 AWG. (AWG stands for American Wire Gauge).

**⚠ CAUTION:** If you use an extension cord, use one that has a minimum wire size of 14 AWG. Be sure your extension cord is no longer than 50 ft. Do not join two extension cords.

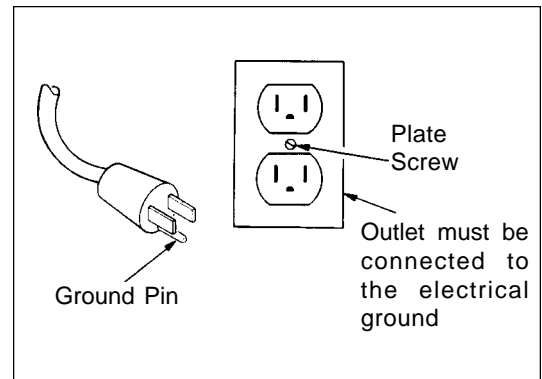

Figure 5

## INSTRUCTIONS FOR CONNECTION TO THE POWER SUPPLY AND ELECTRICAL GROUND - 230 V

**CAUTION:** This machine will operate only on an AC frequency and on the specified electrical voltage shown on the nameplate. Make sure you have the correct frequency and voltage before connecting the power cord to an outlet.

This machine must be connected to an electrical ground circuit in order to protect the operator from electric shock. This machine has an approved power cord with two main conductors and one earthing conductor. Connect the plug to the type of receptacle shown in figure 6. The green and yellow conductor in the cord is the ground wire. Never connect this wire to any terminal other than the ground terminal.

**WARNING:** Always use this machine with an AC three-conductor electrical system connected to the electrical ground. Replace any worn, cut or damaged cords. Replace any damaged plugs, receptacles, or connector bodies. Do not move the machine over an electrical cord. Always lift the cord over the machine.

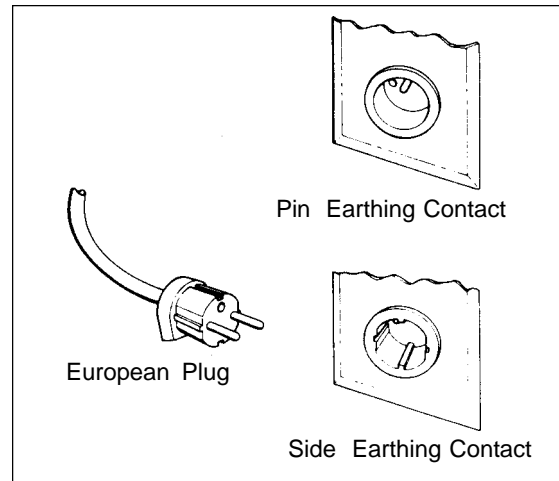

Figure 6

### Extension Cords

Use only an approved extension cord with two main conductors, and one earthing conductor. This machine has a power cord with a wire size of 1.5mm<sup>2</sup>.

**WARNING:** If you use an extension cord, use one that has a minimum wire size of 1.5mm<sup>2</sup>. Be sure your extension cord is no longer than 15 meters. Do not join two extension cords.

**WARNING:** Do not cut, remove or break the ground terminal. Do not try to fit a three-terminal plug into a receptacle or connector body that does not fit the plug. If the receptacle or connector body does not fit the plug, see your authorized Clarke Dealer to get an authorized person to make the connection.

## MACHINE OPERATING INSTRUCTIONS

### How to Clean an Area of Carpet See Figure 7

**⚠ WARNING:** Do not use water that is hotter than 140°F.

To clean an area of carpet, follow this procedure:

1. Start the pump for the solution and the motor for the vacuum on the extractor.
2. Begin at the right-hand corner of the carpet.
3. Hold the floor tool at the angle that gives the best vacuum seal between the tool and the carpet.
4. Apply pressure to the lever for solution release. Pull the tool toward you at a slow, steady speed. To remove as much solution as possible, release the lever before you stop moving backward.
5. To clean the edge of a room, move the tool along the baseboard until the edge of all the carpet is cleaned.
6. To clean a small area of carpet, clean the carpet in sections three feet square. As you make more passes, repeat one inch of the area already cleaned.
7. To remove more liquid from the carpet, make passes over the area already cleaned, but do not apply pressure to the lever for the solution.

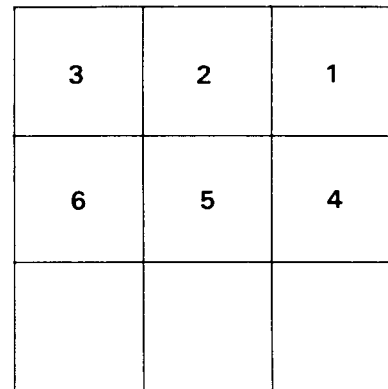

Figure 7

### How To Clean A Larger Area Of Carpet See Fig. 8

To clean a larger area of carpet, follow this procedure:

1. Begin at the right-hand corner of the carpet.
2. Make a pass halfway along the edge of the carpet. Pull the tool backward at a steady speed.
3. Move to the edge of the carpet. Make another pass next to your first pass.
4. As you make more passes, repeat one inch of the area already cleaned. If you use a power brush tool, repeat one inch of the area already cleaned by the brush. Make each pass four inches different in length to prevent making a line in the center of the carpet.
5. Make more passes until half of the carpet is cleaned. To remove more liquid from the carpet, make passes over the area already cleaned, but do not apply pressure to the lever for the solution.
6. Move to the right-hand corner of the part of the carpet not yet cleaned.
7. Make a pass halfway along the edge of the carpet.
8. As you make passes, repeat one inch of the area already cleaned.
9. Make more passes until all of the room is cleaned.

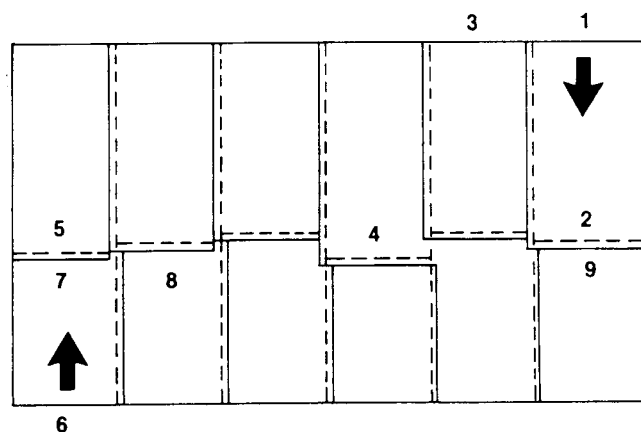

Figure 8

**⚠ CAUTION:** ALTO U.S. Inc. will not be held liable for damage to the carpet, or poor results because of the operator's lack of ability.



## MAINTENANCE

**⚠ WARNING:** Maintenance and repairs must be done by authorized personnel only. Keep all fasteners tight. Use only genuine Clarke parts.

**⚠ WARNING:** Do not operate this machine unless it is completely assembled.

**NOTE:** For maintenance of the floor tools or power brush tools, read the manual given with the tools.

### After Each Use of the Machine

1. To remove unused cleaning solution from the solution tank, put the end of the vacuum hose in the solution tank. Start the vacuum motor. Stop the motor when the tank is empty.
2. To prevent damage to the valves and jets, flush one gallon of clean water through the solution system and the tools.
3. Disconnect the power cord from the outlet.
4. Remove the recovery tank cover.
5. Lift the pail and discard the solution.
6. Rinse the pail with clean water.
7. Use a dry cloth to wipe the tools and both tanks, inside and out.
8. Apply a small amount of silicone lubricant to the quick-disconnect fittings. To prevent damage to the O-rings, do not use an oil lubricant.
9. Inspect the gasket or the vacuum shut-off valve. If the gasket is damaged, replace the gasket.
10. Inspect and clean the filter screen in the bottom of the solution tank. See figure 9. To remove the filter screen, turn the filter counterclockwise. To install the filter, turn the filter clockwise.

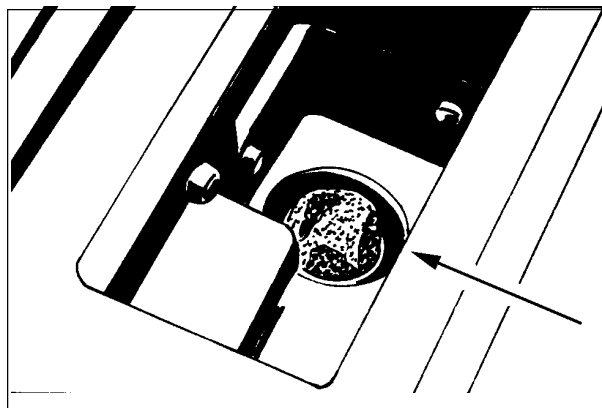

Figure 9

### How To Prevent Damage From Freezing Temperatures

To prevent damage from freezing temperatures follow this procedure:

1. Use the vacuum hose to remove all the solution from the clean solution tank.
2. Connect the solution hose to the extractor and a floor tool.
3. Put approximately 1 quart of antifreeze solution in the solution tank.
4. Put the switch for the pump in the "I" position.
5. Put the end of the floor tool in the recovery pail.
6. Press the lever on the floor tool to activate the pump.
7. Make sure the solution runs through the system.
8. Release the lever on the floor tool to stop the pump.
9. Flush the antifreeze solution from the system before using the extractor.
10. Make sure the machine is the same temperature as the room before using the machine.

#### Electrical

**⚠ WARNING:** Electrical repairs must be done by authorized personnel only.

**⚠ WARNING:** After electrical repairs are done to the machine, the machine must be tested for electrical safety.

#### How To Get Access To The Pump and Vacuum Motor

To get access to the pump and the vacuum motor, follow this procedure:

1. Remove the dome.
2. Empty both tanks.
3. Remove the pail.
4. Remove the ten screws from the lower housing (1).
5. Lift the upper housing from the machine (2). See figure 10.

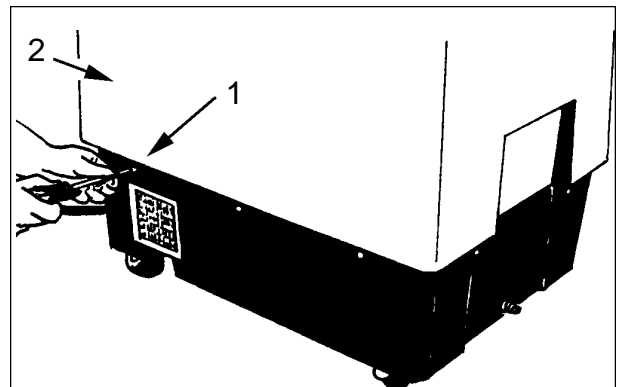

Figure 10

**Maintenance Of The Motor**

This machine has a vacuum motor that uses carbon brushes. The carbon brushes in the motor must be checked every three months, or every 500 hours of operation, whichever comes first. If either of the brushes is shorter than 3/8 inch, replace both of the carbon brushes.

**How To Check The Commutator And The Carbon Brushes**

**⚠ WARNING:** Electrical inspections must be made by a person authorized to make electrical repairs.

To check the commutator and the carbon brushes follow this procedure:

1. Disconnect the power cord from the electrical outlet.
2. Remove the dome.
3. Empty both tanks.
4. Remove the pail.
5. Remove the ten screws from the lower housing.
6. Lift the upper housing from the lower housing.
7. Put the machine on its side.
8. Disconnect the ground wire.
9. Remove the two screws from the bottom of the machine that hold the motor bracket.
10. Remove the plastic motor cover.
11. Inspect the commutator. See figure 11. Take the machine to a Clarke authorized repair location if you see any of the following conditions:

- a. Small holes in the surface of the commutator. See "A" in figure 11.
- b. Uneven color. Look for an even dark brown color. Clean areas or very dark areas indicate a problem. See "B" in figure 11.
- c. High mica. The mica insulation must be lower than the commutator bars. See "C" in figure 11.

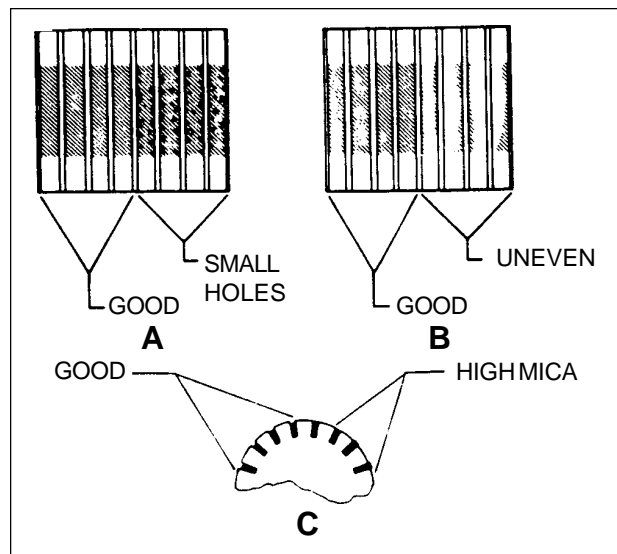

Figure 11

12. To check the carbon brush assemblies, remove the two screws from the holding bracket.
13. Remove the brackets.
14. Remove the carbon brush assemblies.
15. Check the carbon brush assembly. Replace both carbon brush assemblies if either carbon brush is shorter than 3/8 inch. If either brush is shorter than 1/2 inch, order replacement brushes. Be ready to replace both carbon brushes earlier than the normal inspection time.
16. Put the motor brushes in position.
17. Using the two screws, install the bracket that holds the carbon brushes.
18. Install the plastic motor cover.
19. Connect the ground wire.
20. Install the motor holding bracket.
21. Install the lower housing to the upper housing.

## HOW TO CORRECT PROBLEMS IN THE MACHINE

Problem	Cause	Action
<b>The machine will not run.</b>	1. The machine has no power.	1. Make sure the machine is connected to the correct frequency and voltage, and all connections are tight.  Make sure the plug is in the electrical outlet.
	2. The power cord is damaged.	2. Contact an authorized service person to replace the cord.
<b>There is no suction.</b>	1. The vac motor does not run.	1. Put the switch for the vacuum in the "I" position.
	2. The vac motor switch is defective.	2. Contact an authorized service person.
	3. There is a loose motor connection.	3. Contact an authorized service person.
	4. There is an obstruction in the vacuum hose.	4. Remove the obstruction.
	5. The recovery tank is full.	5. Remove the liquid from the tank.
	6. The dome gasket is worn or damaged.	6. Contact an authorized service person to replace the gasket.
	7. The dome is not in the correct position.	7. Put the dome in the correct position.
	8. The internal vac hose is damaged or stopped.	8. Contact an authorized service person.
	9. The dome is damaged.	9. Replace the dome.
	10. The motor brushes are worn.	10. Replace the motor brushes.
	11. A wrong size pail is being used.	11. Use only the pail given with the machine.
<b>There is no pressure.</b>	1. The switch is in the "OFF" position.	1. Put the switch in the "I" position.
	2. The pressure switch is damaged.	2. Contact an authorized service person.
	3. The pump motor will not run.	3. Contact an authorized service person.
	4. The pump motor brushes are worn.	4. Contact an authorized service person.
	5. The quick disconnect fitting is dirty or stopped.	5. Contact an authorized service person.
	6. The solution hose is bent.	6. Straighten the hose. Replace if damaged.
	7. The pump is worn.	7. Contact an authorized service person.
	8. The pump switch is defective.	8. Contact an authorized service person.
	9. The pump connections are loose.	9. Contact an authorized service person.
	10. The pump intake and outlet valves are worn.	10. Contact an authorized service person.
	11. The thermo protector is open.	11. Contact an authorized service person.
	12. The solution tank is empty.	12. Fill the solution tank.
	13. The intake screen is dirty.	13. Clean the screen.
	14. The rectifier in the pump motor is bad.	14. Contact an authorized service person.
<b>The solution tank leaks.</b>	1. The intake gasket is worn.	1. Contact an authorized service person.
	2. The tank is damaged.	2. Contact an authorized service person.
<b>The recovery tank overflows.</b>	1. The float is dirty or damaged.	1. Clean the float. Replace if damaged.
	2. There is too much foam.	2. Put defoamer in the solution. Order P/N 398420.
	3. The float gasket is dirty or damaged.	3. Clean the gasket. Replace if damaged.





**CLARKE**

**TECHNOLOGY**

**EXT 515**

**Extractor**

**Section II**

**Parts and Service Manual**

(78165A)

CLARKE TECHNOLOGY EXT-511  
 Assembly Drawing #1 9/98

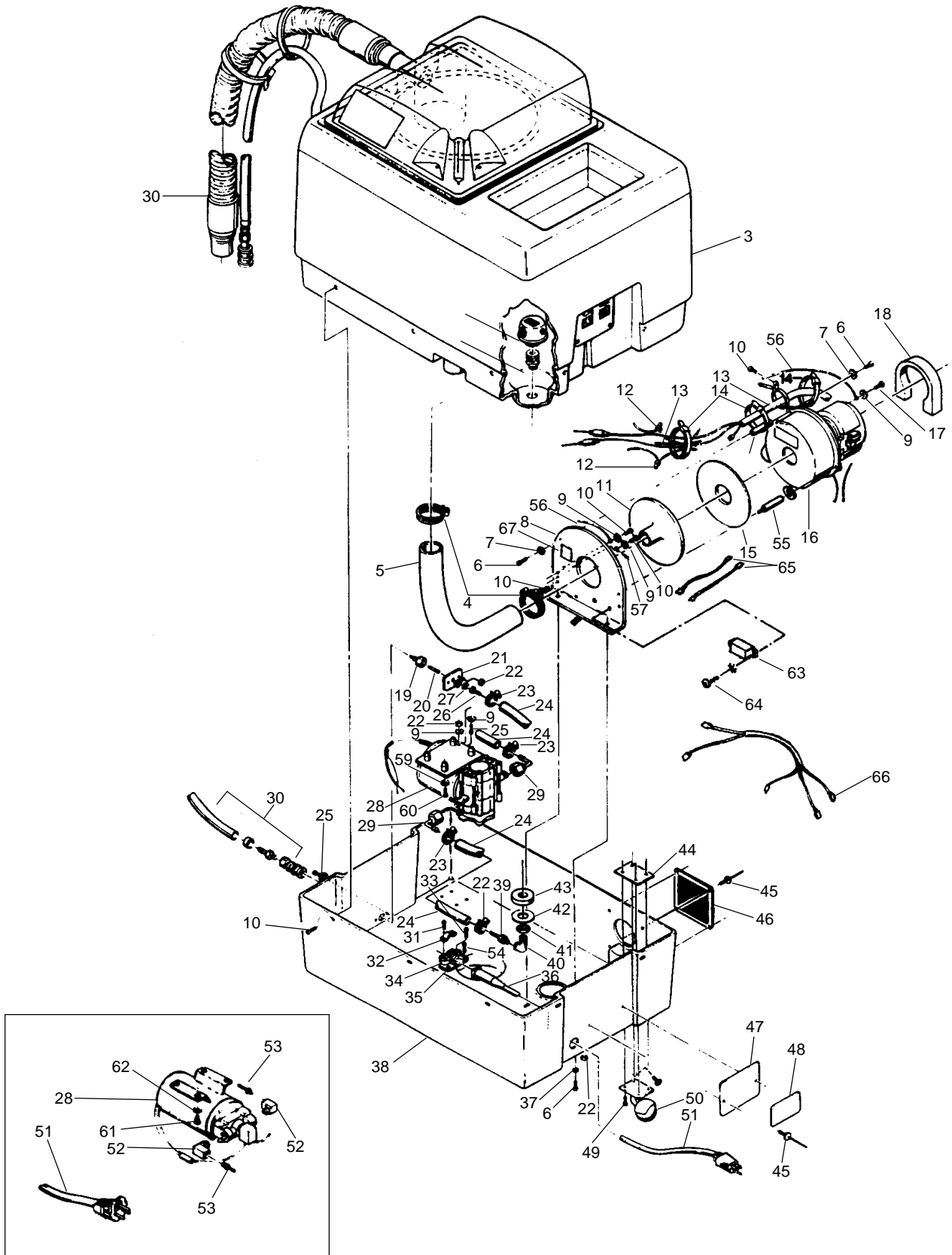

**CLARKETECHNOLOGYEXT-511**  
**Assembly Drawing #1 Parts List 9/98**

Item #	Part No.	Description	Qty.
1	728535	Strainer, Solution Tank	1
2	60306A	Adapter, Filter	1
3	□ 38913C	Tank	Ref.
4	752020	Clamp, Hose .81 to 1.75 range	2
5	35131A	Hose, Vacuum	1
6	85329A	Screw, ¼-20 x 5/8 Pan	7
7	980614	Washer, ¼ Shakeproof	5
8	65903A	Mount, Vac Motor	1
9	□ 980603	Washer, #10 Shakeproof	7
10	85364A	Screw, #10-32 x 3/8	14
11	60307A	Adapter, Vac Motor	1
12	911177	Nut Wire	4
13	49620A	Wire Harness Assembly	1
14	899254	Wire Tie	3
15	34212A	Gasket, Vac Motor Adapter	1
16	44906A	Motor, Vac 120V	1
	44907A	Motor, Vac 230V	1
17	85506A	Screw, #10-24 x ½, Type 23	1
18	34234A	Gasket, Intake Air	1
19	737140	Quick Disconnect, Male	1
20	725729	Nipple, 1/8 Close Pipe	1
21	66617A	Plate, Quick Disconnect Mt.	1
22	920200	Nut, #10-24 Hex	5
23	722030	Clamp, Hose	4
24	694116	Hose	2
25	85323A	Screw, #10-24 x ½	3
26	50300A	Adapter, 1/8p to 3/8 Hose	1
27	81200A	Nut, 1/8 Pipe Lock	1
28	45900A	Pump, 120V	1
	697011	Pump, 230V	1
29	692870	Elbow, Swivel Barb	2
30	15604A	Hose Assembly Applicator	Ref.
31	964004	Screw, M5 x 0.8 x 16 PN	2
32	672012	Clamp, Cord	1
33	964003	Screw, M5 x 0.8 x 20 Pan	2

Item #	Part No.	Description	Qty.
34	672011	Clamp, Strain Relief	1
35	670811	Bracket, Strain Relief	1
36	38002A	Strain Relief	1
37	980646	Washer, ¼ Plain	2
38	□ 30801B	Base	1
39	502406	Coupling, ¼P to 3/8 Hose	1
40	232801	Elbow, Street	1
41	833401	Gasket, Drain	1
42	980630	Washer, 3/4 I.D. Plain	1
43	920264	Nut, 3/4-16 Hex Jam	1
44	66633A	Plate, Nut	4
45	930074	Pop Rivet, 1/8 x ¼ x 5/16	6
46	603801	Grill, Rear Housing	1
47	66634A	Plate, Label Mounting	1
48		Label, Serial No.	1
49	85328A	Screw, ¼-20 x ½	16
50	52100A	Caster, 2" Ball	4
51	42164B	Cord, Extension 120V	1
	42167A	Cord, Extension 230V	1
52	722851	Elbow, 3/8 St. 230V Only	2
53	720270	Adapter, 3/8H x 3/8NPT 230V only	2
54	85353A	Screw, #10-24 x 5/8 Pan	2
55	962453	Screw, ¼-20 Set	1
56	954010	Wire Assembly, Ground	1
57	49033A	Wire Ground Lead, 120V only	1
58	838216	Spacer, 120V only	2
59	980982	Washer, 1#C SAE 120V only	4
60	85361A	Screw, #10-32 x 1 Pn 120V	4
61	85307B	Screw, #10-32 x 5/8 230V only	4
62	980982	Washer, #10 Plain 230V only	4
63	□ 47201A	Filter (CE only)	1
64	□ 962333	Screw (CE only)	6
65	□ 49310A	Lead Assembly (CE only)	2
66	□ 49642B	Harness (CE only)	1
67	□ 77094A	Label (CE only)	1

NOTE: □ indicates a change has been made since last publication of this manual.



**CLARKE TECHNOLOGY EXT-511  
Assembly Drawing #2 & Parts List 5/86**

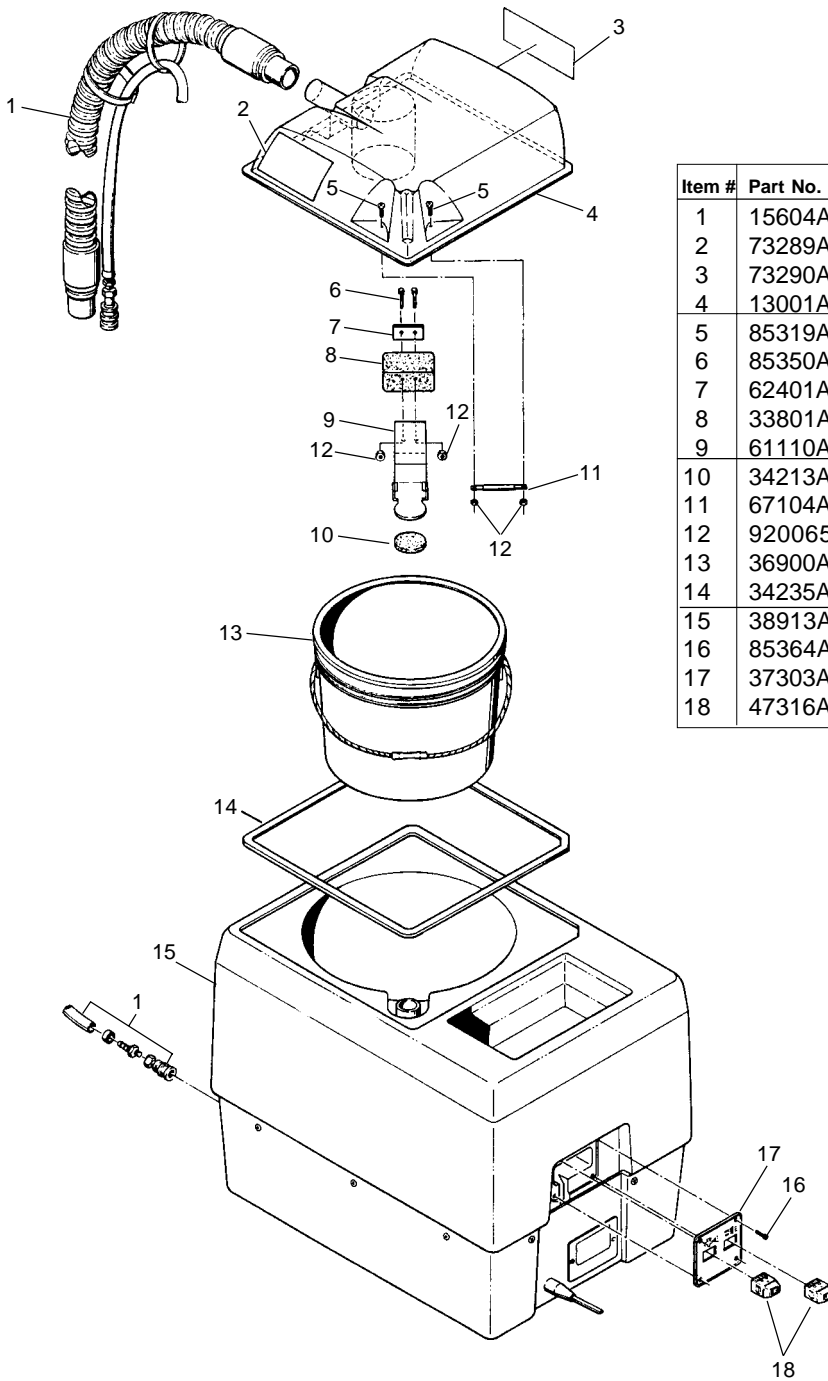

Item #	Part No.	Description	Qty.
1	15604A	Hose Assembly	1
2	73289A	Label, Warning	1
3	73290A	Label, Instruction	1
4	13001A	Dome and Label Assembly	1
5	85319A	Screw, #8-32 x 1/2 Pan	2
6	85350A	Screw, #8-32 x 2 1/2 Pan	2
7	62401A	Clamp, Float	1
8	33801A	Float	1
9	61110A	Bracket, Float	1
10	34213A	Gasket, Float Shut-Off	1
11	67104A	Rod, Float Pivot	1
12	920065	Nut, #8-32 ESNA	4
13	36900A	Pail, Recovery	1
14	34235A	Gasket, Dome Assembly	1
15	38913A	Tank	1
16	85364A	Screw, #10-32 x 3/8	4
17	37303A	Plate, Switch	1
18	47316A	Switch, On-Off	2

**CLARKE TECHNOLOGY EXT-511**  
**10 ft. Hose Assembly Drawing & Parts List 5/86**

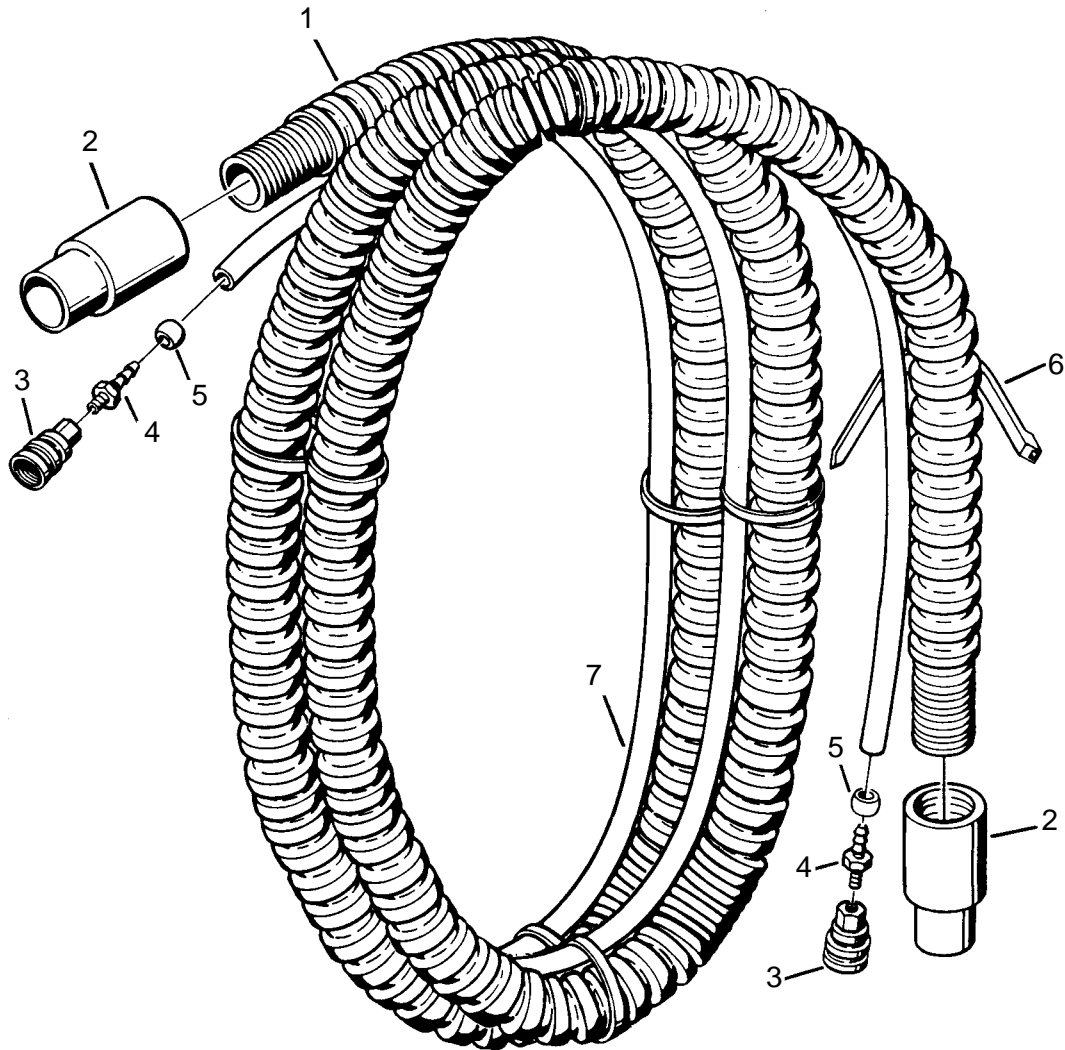

Item #	Part No.	Description	Qty.
1	634117	Hose, Vacuum 1½" I.D. x 10'	1
2	732440	Cuff, Vacuum Hose	2
3	737141	Quick Disconnect, Female	2
4	690209	Adapter, ¾" Hose to 1/8" NPT	2
5	693302	Ferrule	2
6	899254	Tie, Nylon Cable	9
7	35110A	Hose, Applicator	1

**CLARKE TECHNOLOGY EXT-511  
Pump Replacement Parts 5/86**

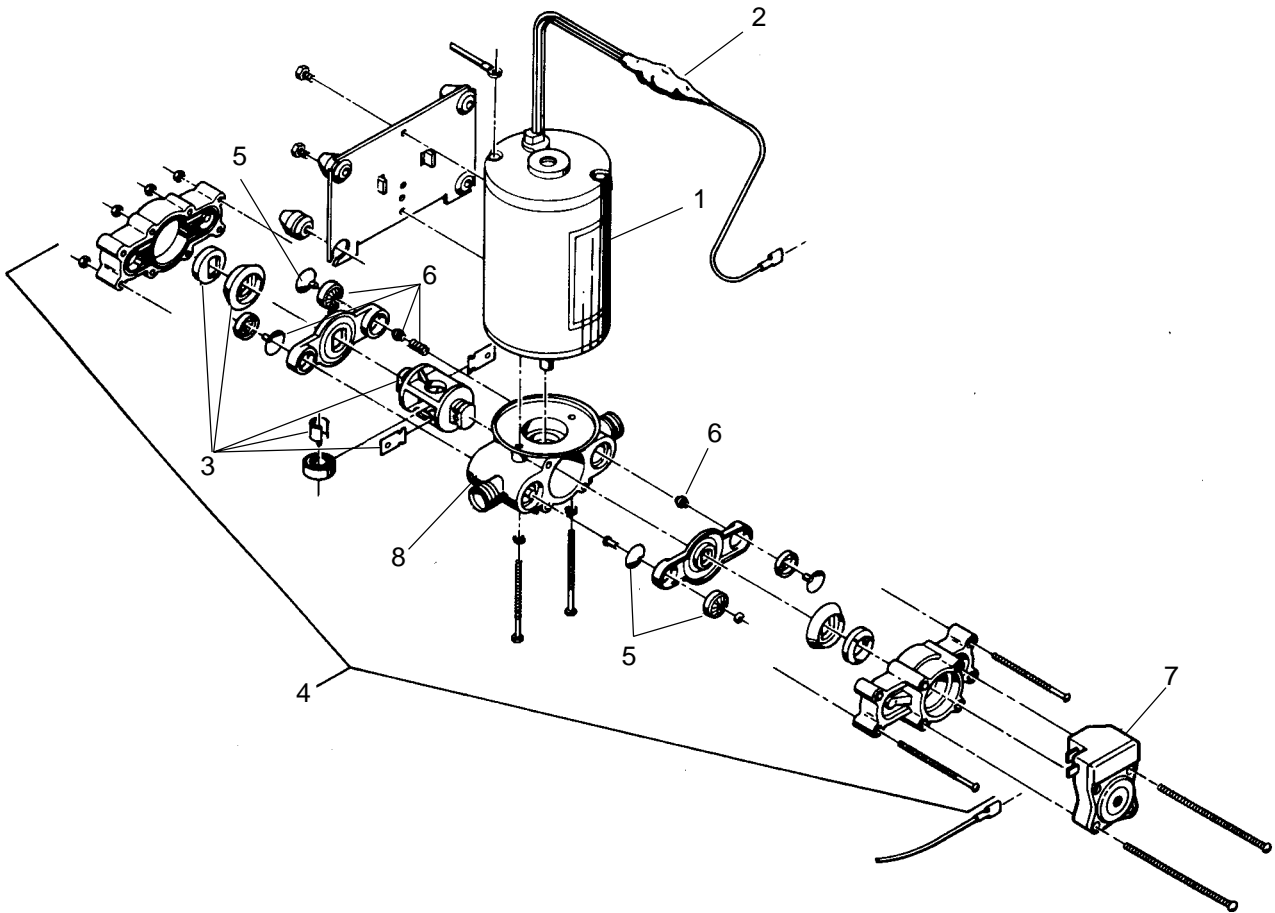

Ref #	Part No.	Description	No. Req.
1	56002A	Motor	
2	912232	Rectifier	
3	697072	Piston and Eccentric	
		Lock Ring	2
		Cap Piston	2
		Eccentric	1
		Bearing	1
		Wear Plate	2
		Piston	1
4	54805A	Head Assembly Complete	
5	692972	Elastomer Assembly	
		Seat Valve	4
		Valve	3
		Diaphragm	2
		Valve	1
		O'Ring	1
6	59701A	Valve By-Pass	
		Seat Valve	2
		Valve	2
		Spring	1
		Valve Stem	1
		Valve Stem	1
7	912233	Switch Micro	
8	54807A	Pump Housing	

**SERVICE PARTS FOR  
230V PUMP #697011**

16400A	Kit - Service
16401A	Kit - Brush (Motor)
46800A	Semiconductor
	Asm. - Rectifier
47300A	Switch - Pressure

**CLARKE TECHNOLOGY EXT-511**  
**Motor 120V #44906A - 9/98**

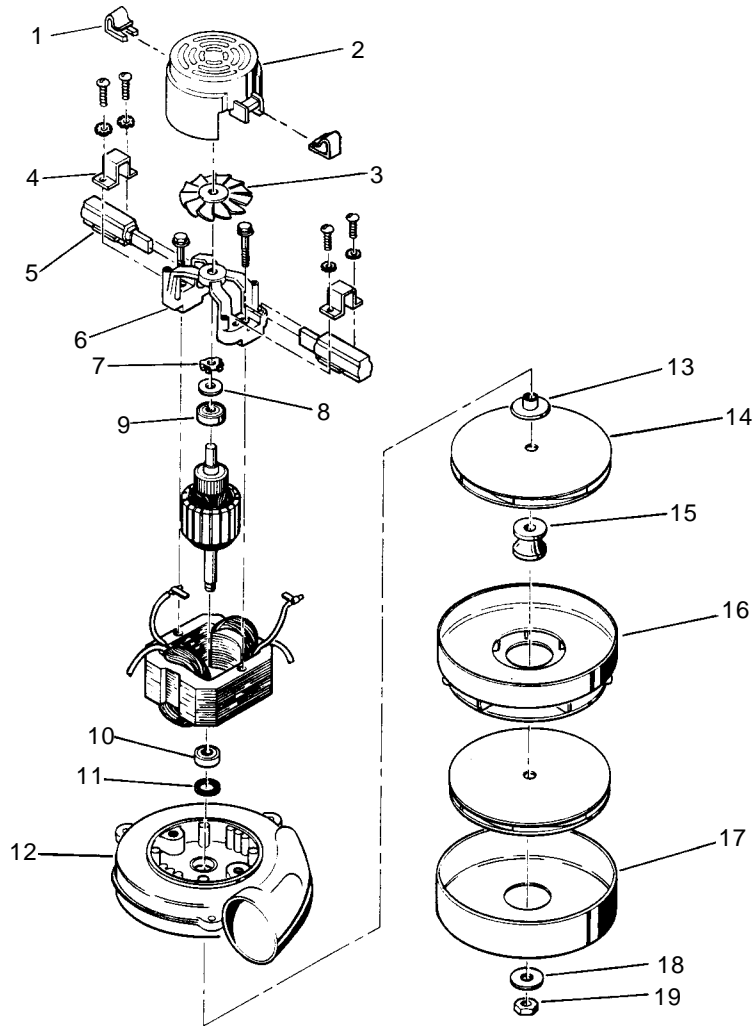

Ref #	Part No.	Description	Qty
1	51913A	Clip (Optional)	2
2	54809A	Housing, Vent	1
3	53905A	Fan	1
4	51914A	Clamp	2
5 □	51401A	Brushes, Carbon (Set of 2)	1
6	50618A	Bracket, End, Commutator	1
7	58600A	Load Spring	1
8	53100A	Disc	1
9	902679	Ball Bearing	1
10	902648	Ball Bearing	1
11	59803A	Washer	1
12	50610A	Bracket, End, Fan	1
13	58501A	Spacer	1
14	653012	Fan, Vacuum	2
15	658201	Spacer	1
16	53907A	Fan, Stationary	1
17	57910A	Shell, Fan	1
18	980205	Washer	1
19	920329	Nut	1

NOTE: □ indicates a change has been made since last publication of this manual.

**CLARKE TECHNOLOGY EXT-511**  
**Motor 230V #44907A - 9/98**

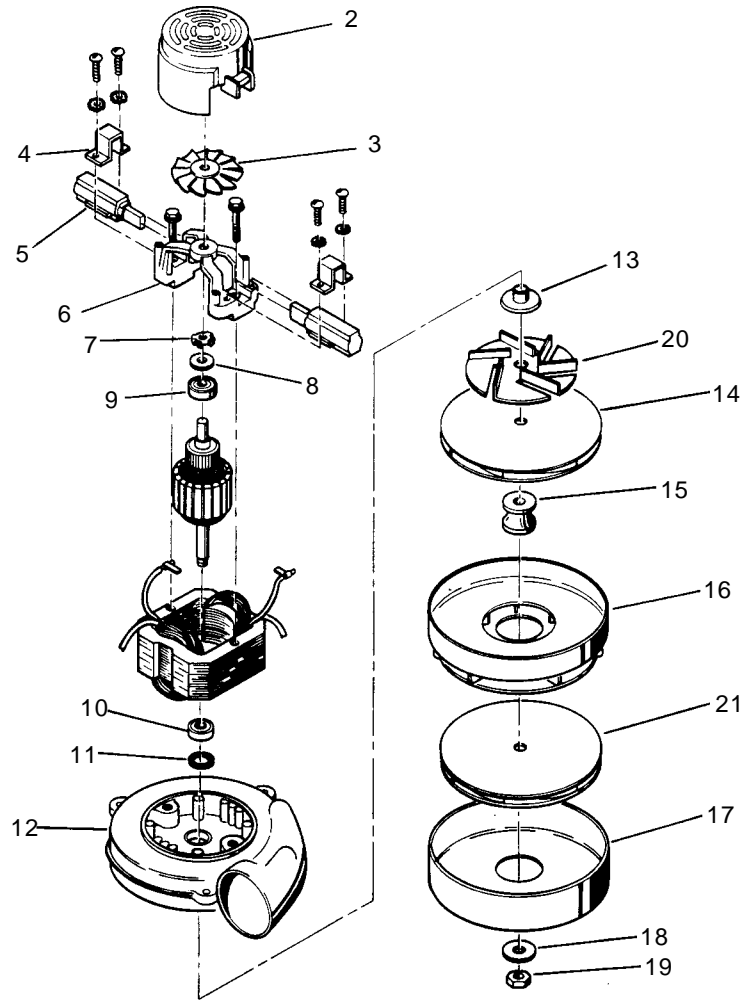

Ref #	Part No.	Description	Qty
1			
2	54809A	Housing, Vent	1
3	53905A	Fan	1
4	51914A	Clamp	2
5	40813A	Brushes, Carbon	2
6	50618A	Bracket, End, Commutator	1
7	58600A	Spring, Load	1
8	53100A	Disc	1
9	902679	Ball Bearing	1
10	902648	Ball Bearing	1
11	59803A	Washer	1
12	50610A	Bracket, End, Fan	1
13	58501A	Spacer	1
14	653012	Fan, Vacuum	1
15	658201	Spacer	1
16	53907A	Fan, Stationary	1
17	57910A	Shell, Fan	1
18	980205	Washer	1
19	920329	Nut	1
20	53906A	Fan	1
21	653012	Fan- Rotating	1

NOTE: □ indicates a change has been made since last publication of this manual.

CLARKE TECHNOLOGY EXT-511  
Wiring Diagram 120V 9/98

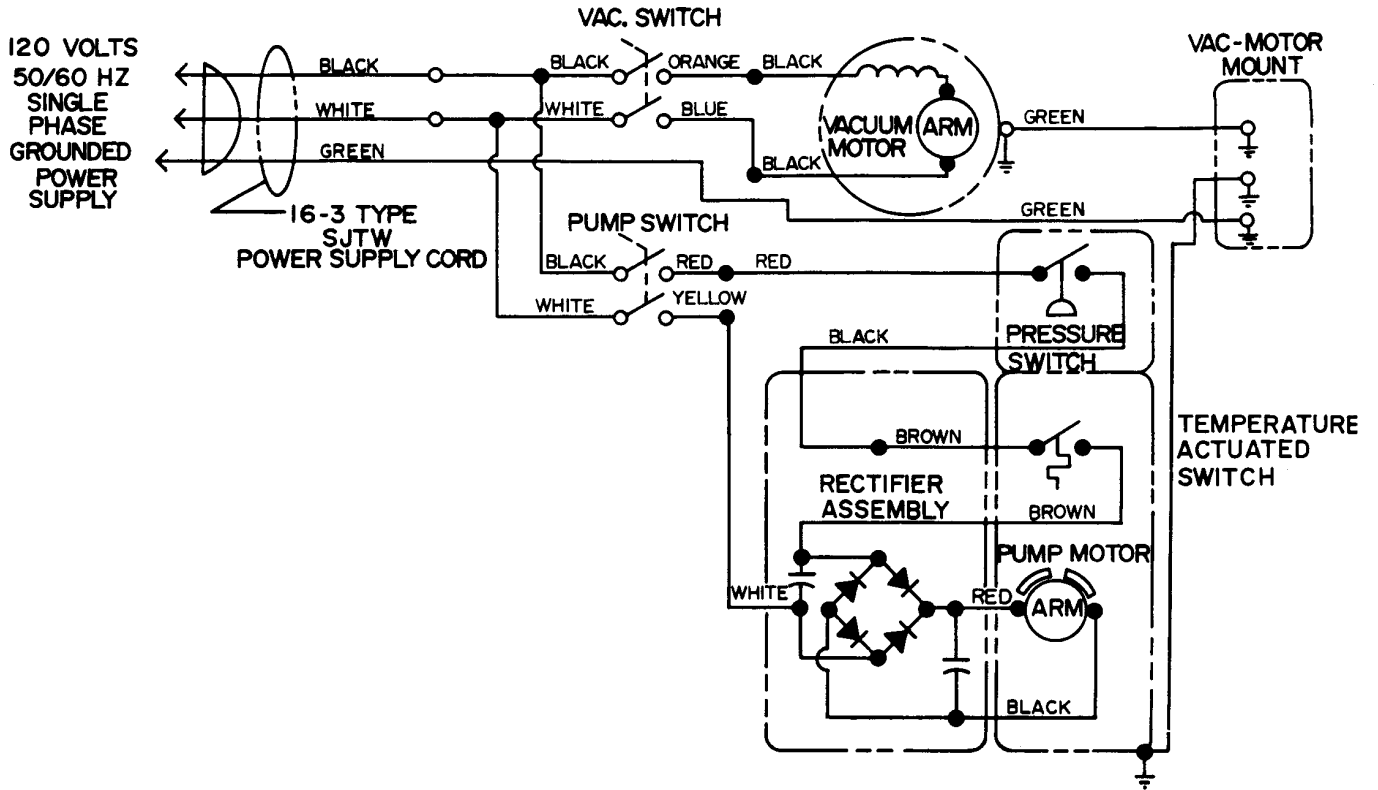

CLARKE TECHNOLOGY EXT-511  
Wiring Diagram 230V 9/98

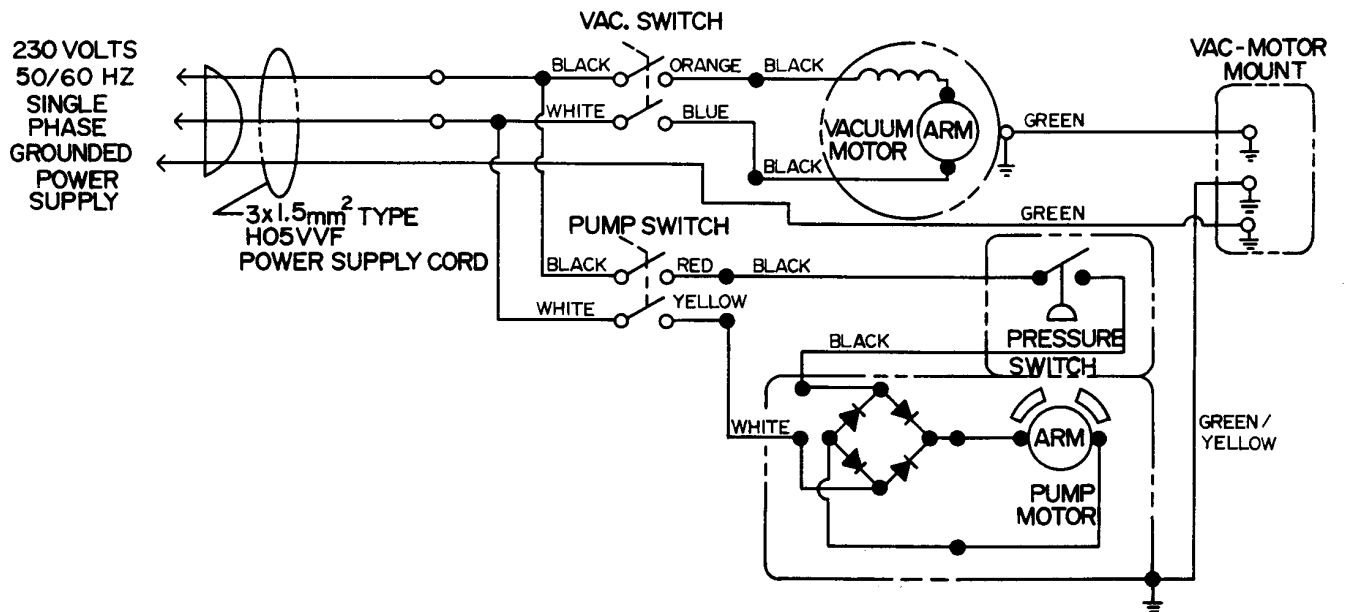



# ALTO® PRODUCT SUPPORT BRANCHES

## U. S. A. Locations

### HEAD OFFICE

ALTO U.S. Inc., St. Louis, Missouri  
16253 Swingley Ridge Road, Suite 200  
Chesterfield, Missouri 63017-1725

### PRODUCTION FACILITIES

ALTO U.S. Inc., Springdale, Arkansas  
2100 Highway 265  
Springdale, Arkansas 72764  
(501) 750-1000

**Customer Service - 1-800-253-0367**

**Technical Service - 1-800-356-7274**

ALTO U.S. Inc., Bowling Green, Ohio 43402  
1100 Haskins

ALTO U.S. Inc., Clearwater, Florida 33765  
1500 N. Belcher Road

### SERVICE FACILITIES

ALTO U.S. Inc., Carlstadt, New Jersey 07072  
150 Commerce Road  
(201) 460-4774

ALTO U.S. Inc., Elk Grove, Illinois 60007  
2280 Elmhurst Road  
(847) 956-7900

ALTO U.S. Inc., Denver, Colorado 80204  
1955 West 13th Ave.  
(303) 623-4367

ALTO U.S. Inc., Houston, Texas 77040  
7215 North Gessner Road

### SALES AND SERVICE FACILITIES

ALTO U.S. Inc., Madison Heights, Michigan 48071-0158  
29815 John R.  
(810) 544-6300

ALTO U.S. Inc., Marietta, Georgia 30062  
1355 West Oak Common Lane  
(770) 973-5225

---

**CLARKE TECHNOLOGY**  
**AMERICAN SANDERS TECHNOLOGY**  
**A.L. COOK TECHNOLOGY**  
**Customer Service Headquarters and Factory**

2100 Highway 265  
Springdale, Arkansas 72764  
(501) 750-1000

**Technical Service**  
1-800-356-7274

## European Locations

### PRODUCTION FACILITIES

ALTO Danmark A/S, Aalborg  
Blytaekkervej 2  
DK-9000 Aalborg  
+45 72 18 21 00

ALTO Danmark A/S, Hadsund  
Industrikvarteret  
DK-9560 Hadsund  
+45 72 18 21 00

### SALES SUBSIDIARIES

ALTO Canada Ltd., Rexdale Ontario  
24 Constellation Ct.  
(416) 675-5830

ALTO Overseas Inc., Sydney (Australia)  
1B/8 Resolution Drive  
Caringbah NSW 2229  
+61 2 9524 6122

ALTO Cleaning Systems Asia Pte Ltd., Singapore  
No. 17 Link Road  
Singapore 619034  
+65 268 1006

ALTO Deutschland GmbH, Fronenberg (Germany)  
Ardeyer Str. 15  
D-58730 Fronenberg  
+49 2373 754 200

ALTO Cleaning Systems (UK) Ltd., Penrith  
Gilwilly Industrial Estate  
Penrith  
Cumbria CA11 9BN  
+44 1768 868 995

ALTO France S.A. Strasbourg  
B.P. 44, 4 Place d'Ostwald  
F-67036 Strasbourg  
Cedex 2  
+33 3 8828 8400

ALTO Nederland B.V. Vianen  
Stuurtweg 4C  
NL-4131 NJ Vianen  
+31 347 324000

ALTO Sverige AB, Molndal (Sweden)  
Aminogatan 18  
Box 4029  
S-431 04 Molndal  
+46 31 706 73 00

ALTO Norge A/S, Oslo (Norway)  
Bjornerudveien 24  
N-1266  
+47 2275 1770



## **CLARKE TECHNOLOGY LIMITED U.S. WARRANTY**

This ALTO Industrial/Commercial Product is warranted to be free from defects in materials and workmanship under normal use and service for a period of one year from the date of purchase, when operated and maintained in accordance with Clarke's Maintenance and Operations instructions.

This warranty is extended only to the original purchaser for use of the product. It does not cover normal wear parts such as electrical cable, rubber parts, hoses and motor brushes.

If a difficulty develops with the product you should:

- a) Contact the nearest authorized Clarke repair location or contact ALTO U.S. Inc. Service Operations Department, 2100 Highway 265, Springdale, Arkansas 72764, for the nearest authorized Clarke repair location. Only these locations are authorized to make repairs to the product under this warranty.
- b) Return the product to the nearest Clarke repair location. Transportation charges to and from the repair location must be prepaid by the purchaser.
- c) Clarke Technology will repair the product and/or replace any defective parts without charge within a reasonable time after receipt of the product.

Clarke's liability under this warranty is limited to repair of the product and/or replacement of parts and is given to purchaser in lieu of all other remedies, including INCIDENTAL AND CONSEQUENTIAL DAMAGES.

THERE ARE NO EXPRESS WARRANTIES OTHER THAN THOSE SPECIFIED HEREIN. THERE ARE NO WARRANTIES WHICH EXTEND BEYOND THE DESCRIPTION OF THE FACE HEREOF. NO WARRANTIES, INCLUDING BUT NOT LIMITED TO WARRANTY OF MERCHANTABILITY, SHALL BE IMPLIED. A warranty registration card is provided with your ALTO product. Return the card to assist ALTO in providing the performance you expect from your new floor machine. ALTO U.S. Inc., 2100 Highway 265, Springdale, Arkansas 72764.

**CLARKE TECHNOLOGY reserves the right to make changes or improvements to its machine without notice.  
Always use genuine Clarke Parts for repair.**



**CLARKE TECHNOLOGY  
2100 Highway 265  
Springdale, Arkansas, 72764**