

Ref. Description	Part No.	No.
1	161023	Fan Nut - Black
2	164686	Fan
3	162481	Bearing Retainer Clamp
4	17773	+* Bearing Retainer Clamp
5	18001	* Screw
6	17001FW	* Screw
7	16499FW	+ Bearing Retainer Spring
8	16130	* Washer - Absorbent
9	15605	Motor Bearing
10	17499	+* Bearing Shroud
11	15874	Motor Brush Holder
12	18307	Motor Brush Assem.
13	15785	Armature Assem.
14	161337	Field Coil
15	15836	* Lock Ring
16	21312720	* Washer
17	40404108	Gasket
18	49417AZ	+* Screw
19	161029	Motor Housing
20	164987	+ Lower Motor Housing
21	15918	+ Gasket
22	19990AG	Hose
23	16158	Detergent Tube
24	14492	Cord Clamp
25	161239	Inside Thrust Clip
26	160350	Drive Gear Shaft
27	161024	Bevel Drive Gear
28	40404103	+ Outside Thrust Clip
29	160342	+ Shaft Retainer
30	15738EF	+* Screw
31	163955	+* Field Pad - 1/4" Thick
32	160849AG	Motor Cover
33	45517	* Wire Holder

Model 3600 Motor Assem.

Use Power Head Comp. 164688 +

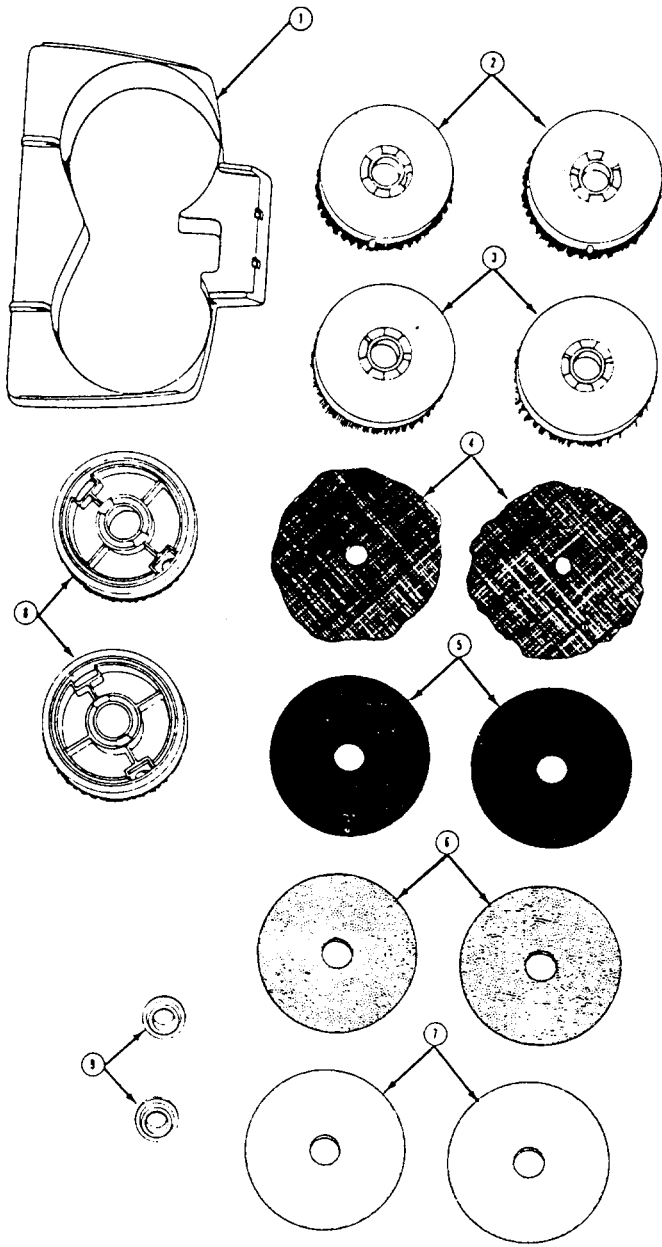

Ref. No.	Part No.	Description
1	37275005	Rug Shampoo Attach.
2	48436009	+ Polishing Brush
3	48436008	Scrubbing Brush
4	18360	High Lustre Pads - Pair
5	18361	Felt Buffing Pads - Pair
6	18362	Cleaning - Waxing Pads - Pair
7	18363	Damp Mop Pads - Pair
8	15636	Rug Shampoo Brush
9	15844	Pad Fasteners
	13128	Bags for Pads (Not Illustrated)
	18996	Steel Wool Pads - Pair

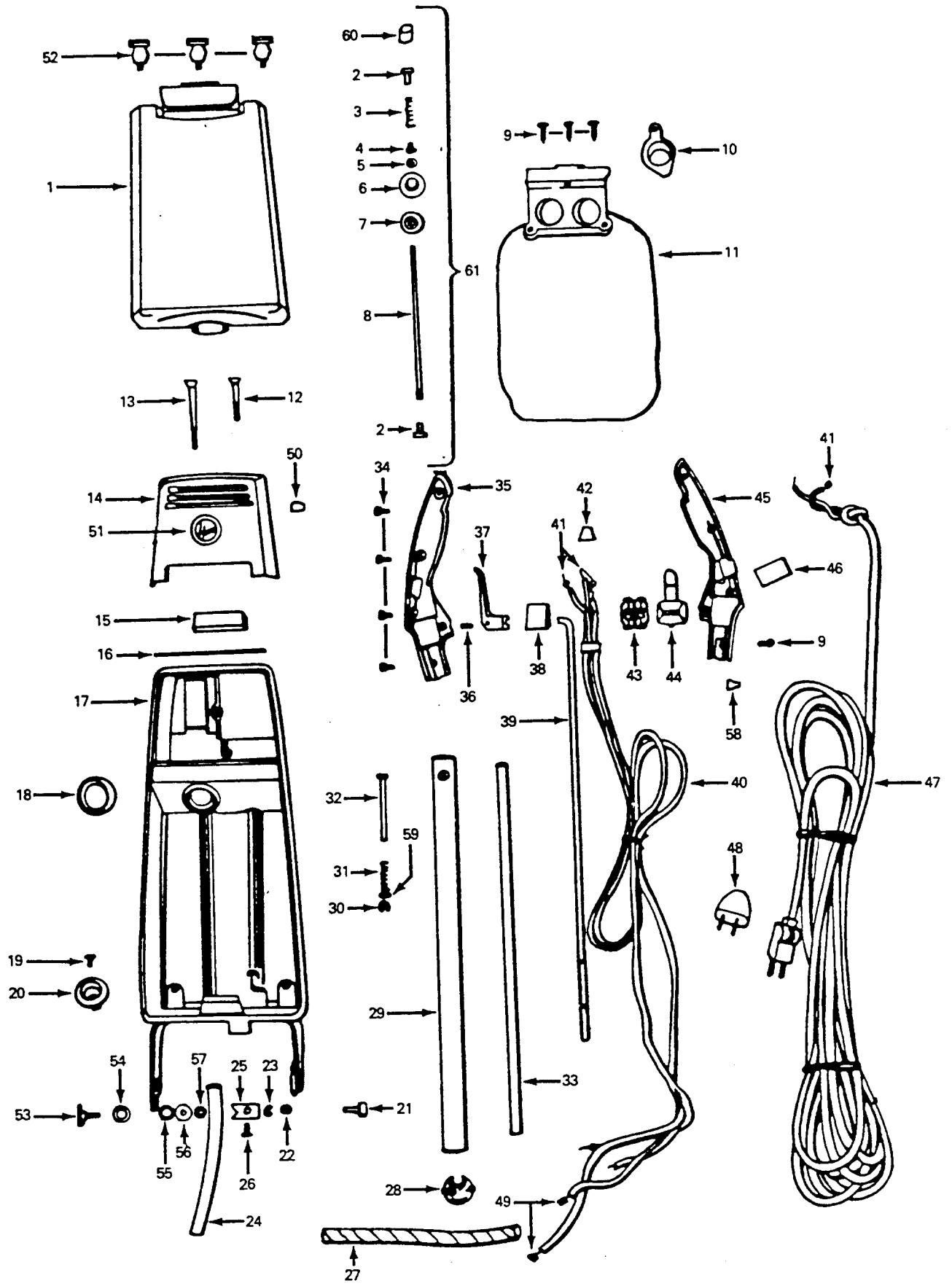

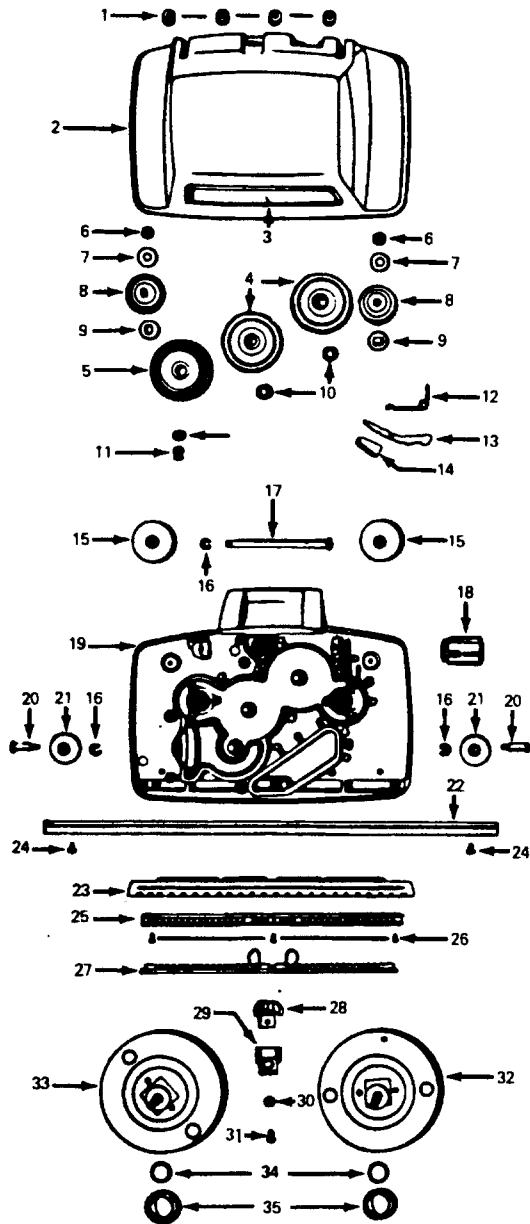

Ref.	Part Description	No.	No.
1	16125AY Capsert		
	15847LL + Hood		
	167215DL + Hood - 3614		
	164961DL + Hood - 3616		
	42271018 + Hood Assem. - EW - 3614-01		
3	16133 + Nameplate		
	164857 + Nameplate - 3616		
4	15745BZ Idler Gear		
5	161028BZ Bevel Gear		
6	15887 * Hex Nut		
7	21312714 * Washer		
8	161328 Brush Shaft Gear		
9	15889 +* Washer		
10	21312715 +* Washer		
11	40404064 Compression Spring		
12	16206AY Handle Control Lever Spring		
13	15910AY Handle Control Lever		
14	34207AG Foot Pad		
15	32175003 Caster Wheel		
16	15836 * Lock Ring		
17	40404082 Rear Wheel Shaft		
18	15603AG Foamer Nozzle		
19	42273014 Gear Housing		
20	15505 + Front Wheel Shaft		
21	38521002 Front Wheel - AG		
22	36231118 Furniture Guard		
23	15808 Squeegee Blade		
24	49571AY + Rivet		
25	162091GA Squeegee Blade Bracket		
26	163598 * Screw		
27	162193 Filter Bar		
28	18331 Brush Stop Spring		
29	15911 Brush Stop		
30	17920 +* Washer		
31	18001 * Screw		
32	18255 Brush Shaft & Inertia Plate - L.H.		
33	18254 Brush Shaft & Inertia Plate - R.H.		
34	15534 "O" Ring		
35	15841BZ Brush Carrier		

ITEMS NOT ILLUSTRATED

163356	+ Lens - 3616
164854	+* Screw (Lens) - 3616
164859DL	+ Lens Gasket - 3616
164933	+ Expansion Nut - 3616
165024	+ Light Socket Comp. - 3616
160508	+ Screw - 3616
164980	+ Terminals (Light Leads) - 3616
42241	Bulb - All Models
16297	+* Screw - Self Tapping (Hood Attach.)

Model 3600 Gear Housing Assem.

Use Power Head Comp. 164688 +