

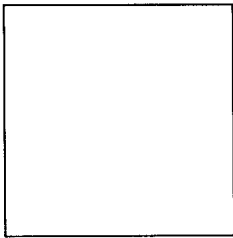

CONQUEST™



ASSEMBLY SCHEMATIC

MODEL NO.

C1820

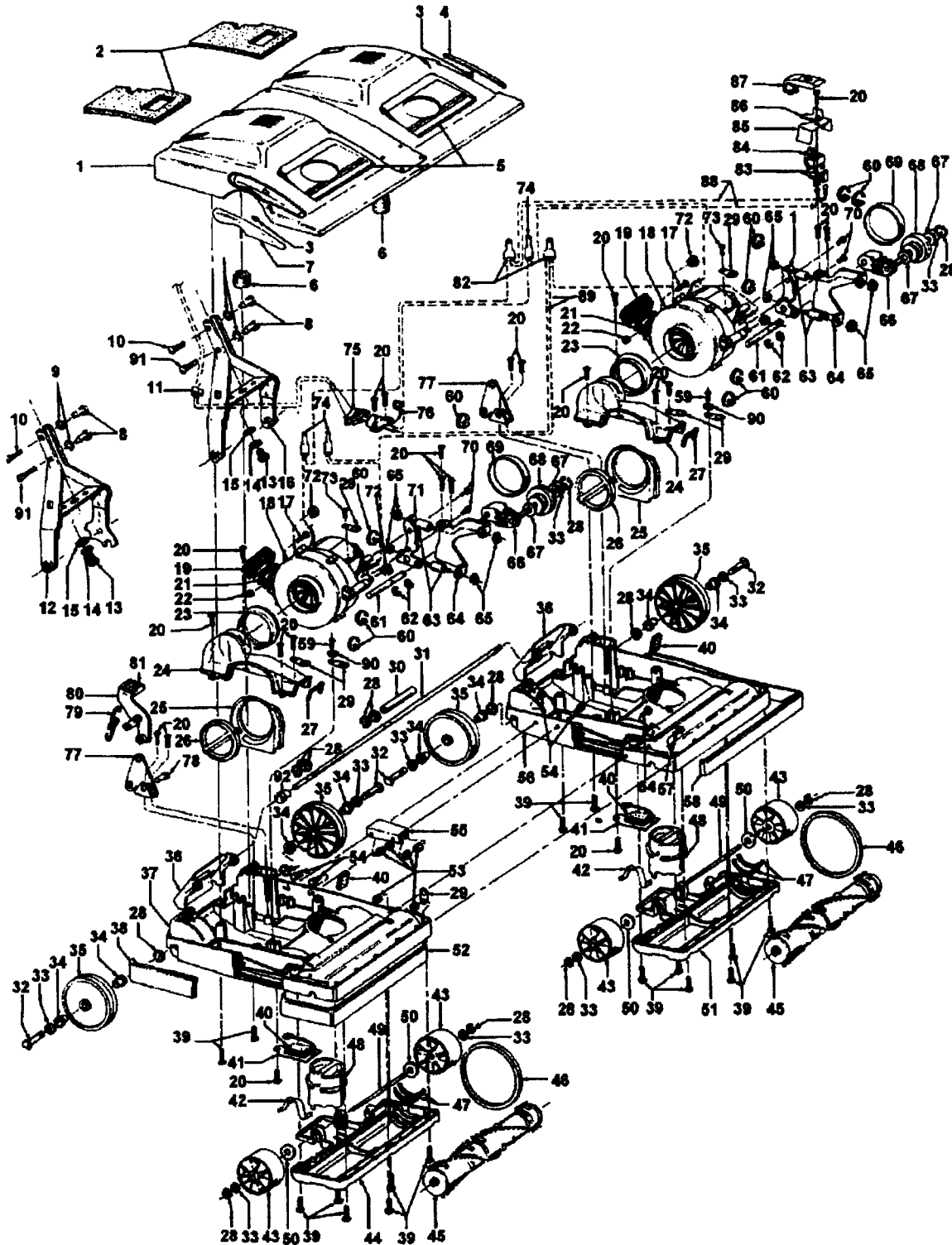



CONQUEST™

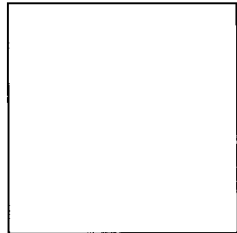

PART LISTING

MODEL No.

C1820

ITEM	PART NUMBER	MODELS TO FIT	PART DESCRIPTION
1	42251337	C1820	TWIN HOOD
2	38783005	C1820	INTAKE DUCT GASKET
3	21364102	C1820	SPEED NUT
4	36222014	C1820	WEAR STRIP - LEFT
5	51353002	C1820	HOOD NAME PLATE
6	31164004	C1820	MOTOR CUSHION
7	36222021	C1820	WEAR STRIP - RIGHT
8	32277021	C1820	HANDLE NUT
9	013704--	C1820	LOCK WASHER
10	21631302	C1820	HANDLE BOLT
11	36172015	C1820	CORD RETAINER
12	41416081	C1820	BAIL / HANDLE FORK
13	21811027	C1820	BOLT
14	21356014	C1820	LOCK WASHER
15	21312799	C1820	FLAT WASHER
16	41416082	C1820	BAIL / HANDLE FORK
17	21765140	C1820	SCREW
18	43574116	C1820	MOTOR ASSEMBLY
19	38671008	C1820	EXHAUST FLANGE BELLOW
20	21447003	C1820	SCREW
21	34797008	C1820	CLAMP BAND
22	015854EF	C1820	NUT
23	38671005	C1820	DUCT BOOT
24	38657020	C1820	AIR DUCT
25	41119008	C1820	CAP LOCK ASSEMBLY
26	37257282	C1820	CAP
27	34253013	C1820	AIR DUCT GASKET
28	160017--	C1820	LOCK RING
29	045517--	C1820	WIRE HOLDER
30	31744025	C1820	SPACER
31	32543014	C1820	BAIL / HANDLE FORK SHAFT
32	32512001	C1820	REAR WHEEL AXLE
33	163110--	C1820	WASHER
34	162143--	C1820	REAR WHEEL BEARING
35	38522036	C1820	REAR WHEEL
36	42256106	C1820	EXHAUST FLANGE ASSEMBLY



CONQUEST™

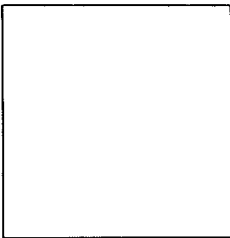

PART LISTING

MODEL No.

C1820

ITEM	PART NUMBER	MODELS TO FIT	PART DESCRIPTION
37	37241120	C1820	MAIN BODY / NOZZLE BASE - RIGHT
38	36231154	C1820	FURNITURE GUARD - SHORT
39	21447215	C1820	SCREW
40	34141005	C1820	MOTOR CUSHION
41	35121001	C1820	ACCESS DOOR
42	38381005	C1820	SPRING
43	38522034	C1820	FRONT WHEEL
44	37245096	C1820	BOTTOM PLATE / NOZZLE GUARD - RIGHT
45	48416035	C1820	AGITATOR COMPLETE
46	38528013	C1820	V-BELT
47	38781008	C1820	AGITATOR PULLEY GASKET
48	36436005	C1820	HEIGHT ADJUSTMENT CAP
49	32543005	C1820	FRONT AXLE
50	21312754	C1820	WASHER
51	37245066	C1820	BOTTOM PLATE / NOZZLE GUARD - LEFT
52	36231008	C1820	FURNITURE GUARD
53	1107602-	C1820	LOCK NUT
54	21781154	C1820	SCREW
55	34612002	C1820	BRACKET
56	37241119	C1820	MAIN BODY / NOZZLE BASE - LEFT
57	049417AZ	C1820	SCREW
58	36231007	C1820	FURNITURE GUARD
59	166648AW	C1820	SCREW
60	27479307	C1820	CABLE TIE
61	31534001	C1820	SHAFT PULLEY ARM SUPPORT
62	013730--	C1820	LOCK RING
63	3724010	C1820	SANDWICH MOUNT
64	36321006	C1820	MOTOR SUPPORT BRACKET
65	21852158	C1820	NUT
66	43256007	C1820	PULLEY ARM SHAFT
67	31158008	C1820	BEARING
68	43256002	C1820	PULLEY ASSEMBLY
69	38528036	C1820	BELT
70	017001FW	C1820	SCREW
71	36321002	C1820	MOUNTING BRACKET
72	21652005	C1820	HEX NUT



CONQUEST™

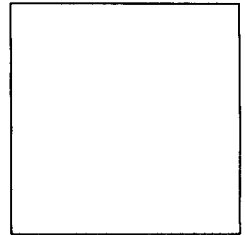

PART LISTING

MODEL No.

C1820

ITEM	PART NUMBER	MODELS TO FIT	PART DESCRIPTION	
73	017001FW	C1820	SCREW	
74	012227--	C1820	TERMINALS	
75	36216008	C1820	CORD PROTECTOR	
76	27478611	C1820	STRAIN RELIEF	
77	35214009	C1820	FOOT LEVER SUPPORT	
78	32215002	C1820	SHAFT	
79	38335008	C1820	SPRING	
80	43151006	C1820	HANDLE CONTROL LEVER	
81	38426030	C1820	FOOT PAD	
82	018972--	C1820	TERMINAL - INSULATED	
83	162961--	C1820	INSULATING POD	
84	28212009	C1820	SWITCH	
85	68182547	C1820	SWITCH PROTECTOR	
86	36171030	C1820	SWITCH CLAMP	
87	38426047	C1820	SWITCH PEDAL	
88	46173041	C1820	LEAD WIRE - BLACK	
89	46314021	C1820	CORD ASSEMBLY	
90	015854EF	C1820	NUT	
91	21831024	C1820	HANDLE BOLT	
92	32172010	C1820	BUSHING	
	58353101	C1820	DUST CUP SUPPORT	
	58433005	C1820	TUBE	



CONQUEST™

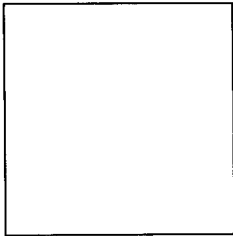

ASSEMBLY SCHEMATIC

MODEL No.
C1820

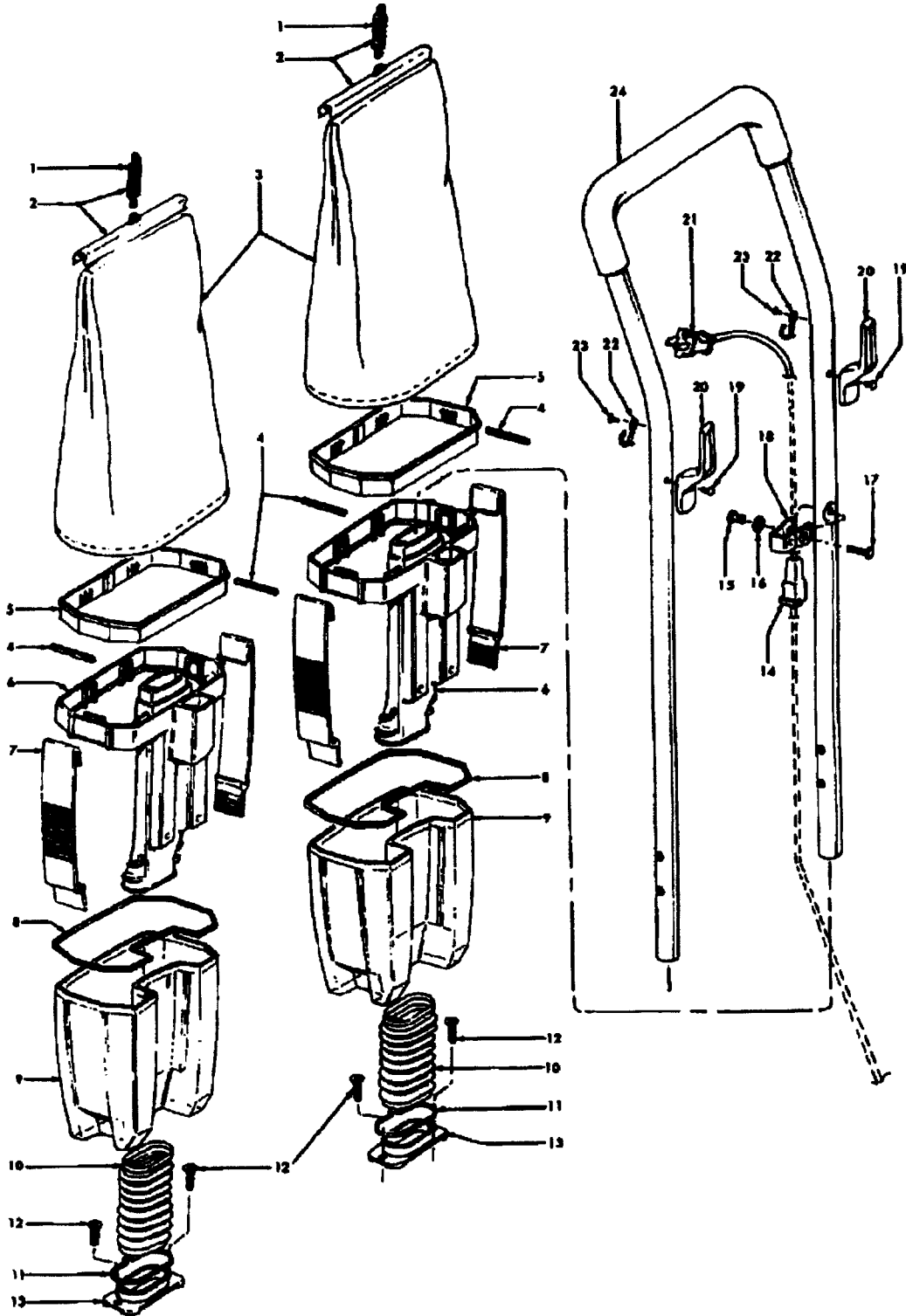



CONQUEST™

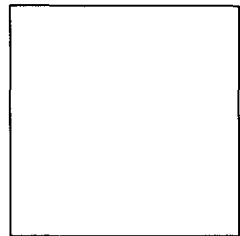

PART LISTING

MODEL No.

C1820

ITEM	PART NUMBER	MODELS TO FIT	PART DESCRIPTION	
1	38336019	C1820	BAG CLIP SPRING	
2	41128016	C1820	BAG SPRING / CLIP ASSEMBLY	
3	43667056	C1820	CLOTH BAG ASSEMBLY	
	013759--	C1820	LOCK RING	
4	34122009	C1820	SEAL	
5	35173001	C1820	BAG EXPANDER	
6	41427012	C1820	CUP SUPPORT	
7	36155011	C1820	LATCH	
8	34123020	C1820	GASKET	
9	38775001	C1820	DIRT CUP	
10	38673001	C1820	BELLOWS	
11	015854EF	C1820	NUT	
	017206--	C1820	SCREW	
	049044--	C1820	CLAMP BAND	
12	36112002	C1820	SCREW	
13	41424018	C1820	BAG FLANGE	
14	36215025	C1820	CORD PROTECTOR	
15	32277008	C1820	HANDLE CLAMP	
16	013704--	C1820	LOCK WASHER	
17	21631302	C1820	HANDLE BOLT	
18	34785017	C1820	CORD RETAINER	
19	21288010	C1820	POP RIVET	
20	39441016	C1820	CORD CLIP	
21	46383193	C1820	POWER CORD	
	91001025	C1820	POWER CORD - SUBSTITUTION	
22	161184--	C1820	BAG SUPPORT HOOK	
23	21288401	C1820	BLIND RIVET	
24	48646080	C1820	HANDLE COMPLETE	



CONQUEST™

ASSEMBLY SCHEMATIC

MODEL NO.

C1820

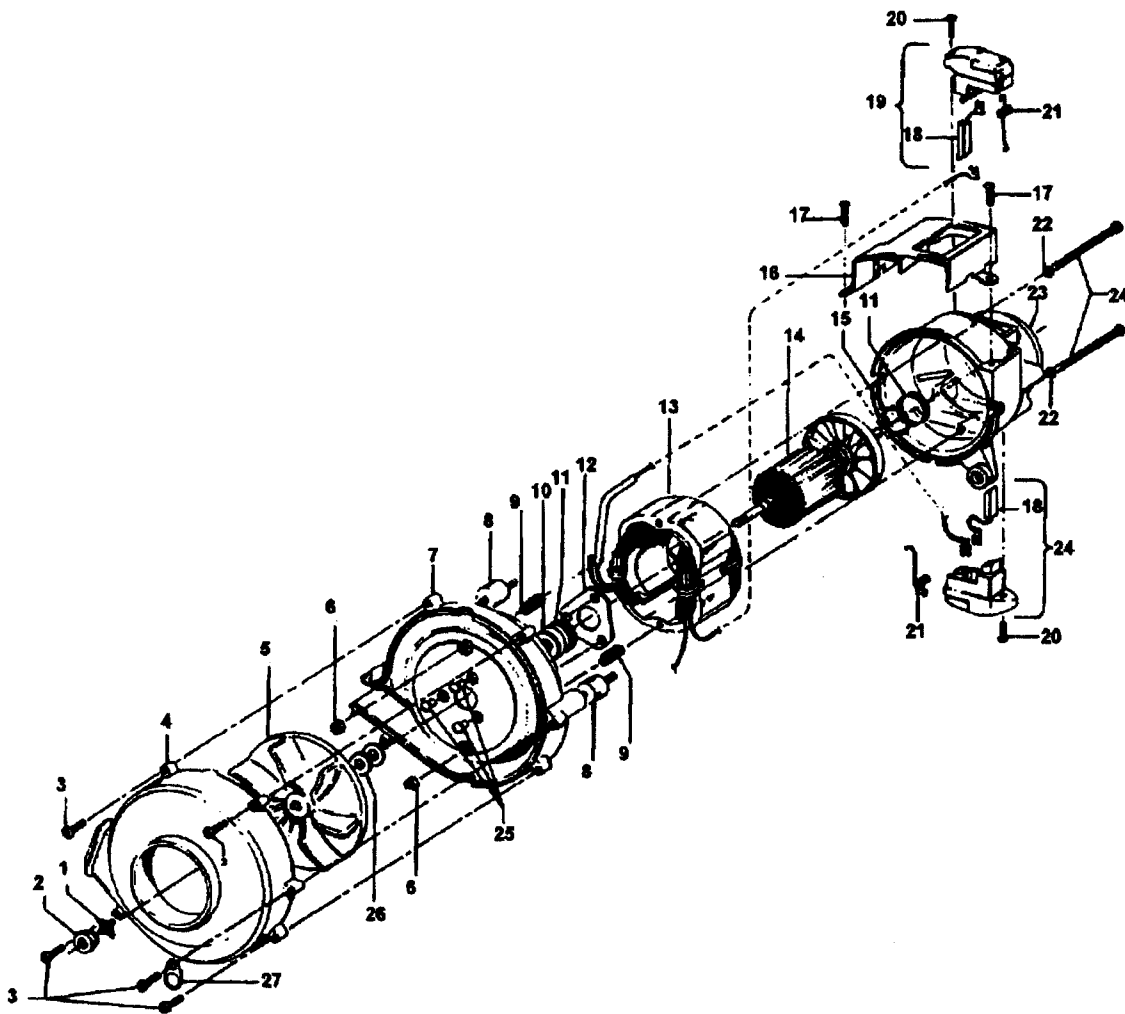



CONQUEST™

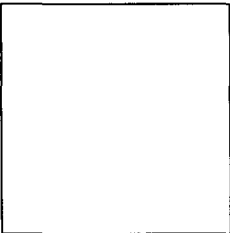

PART LISTING

MODEL No.

C1820

ITEM	PART NUMBER	MODELS TO FIT	PART DESCRIPTION
1	36128003	C1820	LOCK WASHER
2	33426001	C1820	NUT
3	21447072	C1820	SCREW
4	38736025	C1820	FAN CHAMBER COVER
5	38755012	C1820	FAN
6	21641557	C1820	NUT
7	43588018	C1820	FAN CHAMBER ASSEMBLY
8	32724015	C1820	SANDWICH MOUNT
9	012854--	C1820	SPRING
10	24152807	C1820	MOTOR BEARING - 8MM
11	24198001	C1820	STAR RING
12	012025--	C1820	MOTOR BEARING RETAINER
13	90001007	C1820	FIELD COIL - 6.5
14	44765184	C1820	ARMATURE - 5.2
	44765187	C1820	ARMATURE
15	21345115	C1820	WAVE SPRING WASHER
16	37257086	C1820	AIR INTAKE DUCT
17	21447041	C1820	SCREW
18	47315010	C1820	BRUSH AND TERMINAL ASSEMBLY
19	47318008	C1820	BRUSH CARRIER
20	21479302	C1820	SCREW
21	38353004	C1820	SPRING
22	21338006	C1820	LOCK WASHER
23	37191090	C1820	MOTOR HOUSING
24	21563061	C1820	SCREW
25	012503EF	C1820	RIVET
26	166563--	C1820	WASHER
27	045517--	C1820	WIRE HOLDER



CONQUEST™

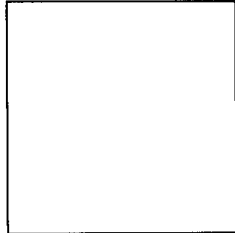

ASSEMBLY SCHEMATIC

MODEL No.

C1820

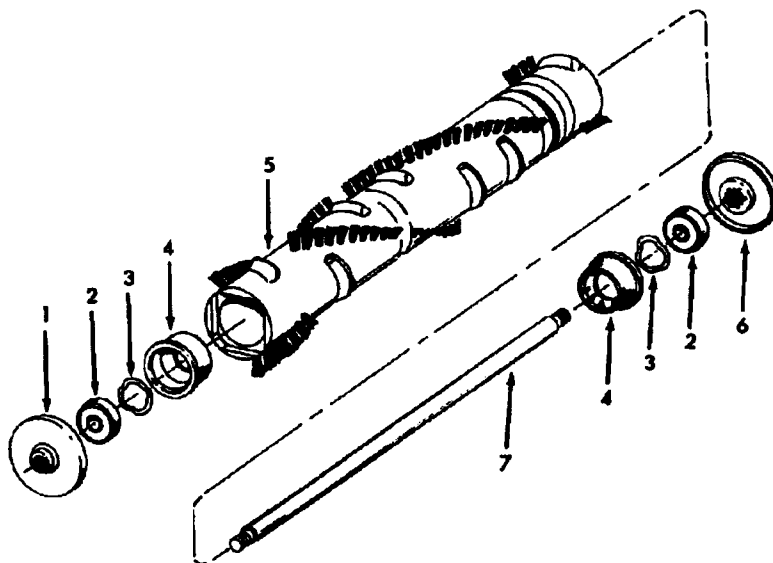
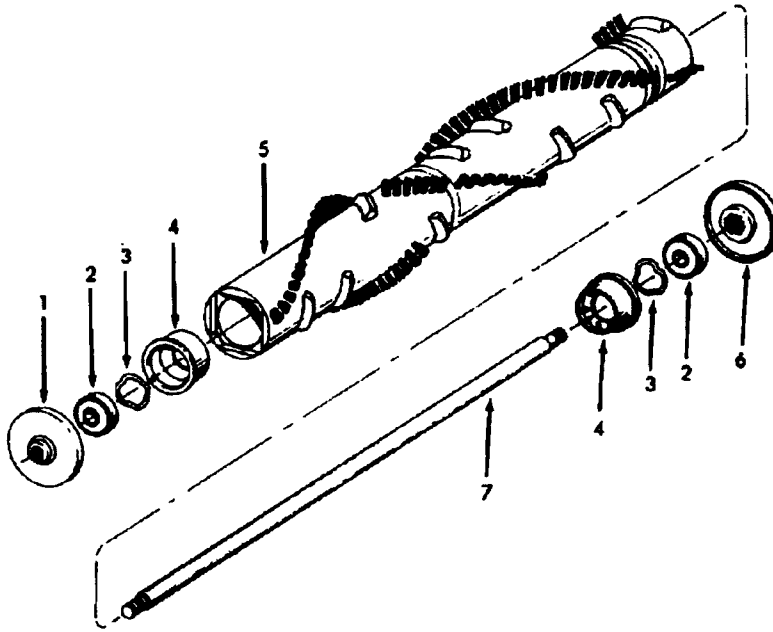



CONQUEST™

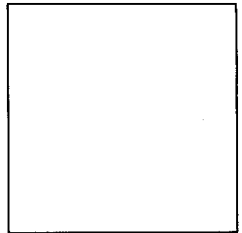

PART LISTING

MODEL No.

C1820

ITEM	PART NUMBER	MODELS TO FIT	PART DESCRIPTION	
1	41435066	C1820	THREAD GUARD ASSEMBLY	
2	24152807	C1820	MOTOR BEARING - 8MM	
3	21345113	C1820	WAVE SPRING WASHER	
4	36422004	C1820	AGITATOR END	
5	48416013	C1820	AGITATOR BODY AND ENDS - 14"	
	48416017	C1820	AGITATOR BODY AND ENDS - 18"	
6	41435061	C1820	THREAD GUARD ASSEMBLY	
7	32873004	C1820	AGITATOR SHAFT - 18"	
	32873007	C1820	AGITATOR SHAFT - 14"	
	48416035	C1820	AGITATOR COMPLETE - 14"	
	48416036	C1820	AGITATOR COMPLETE - 18"	